

Mackie Control Universal Pro Mackie Control Extender Pro Quick-Start Guide

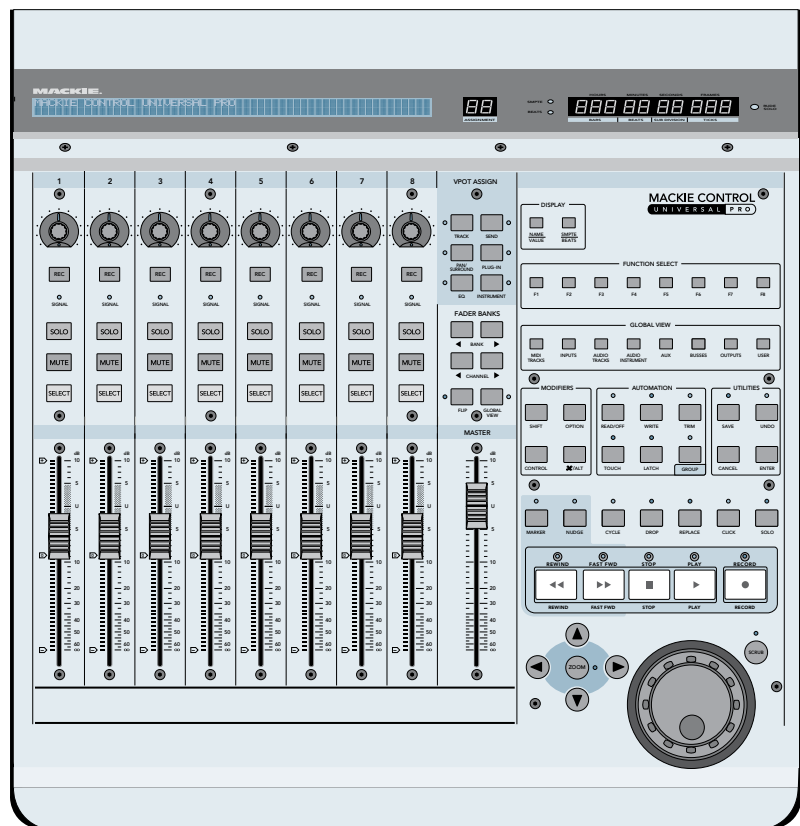
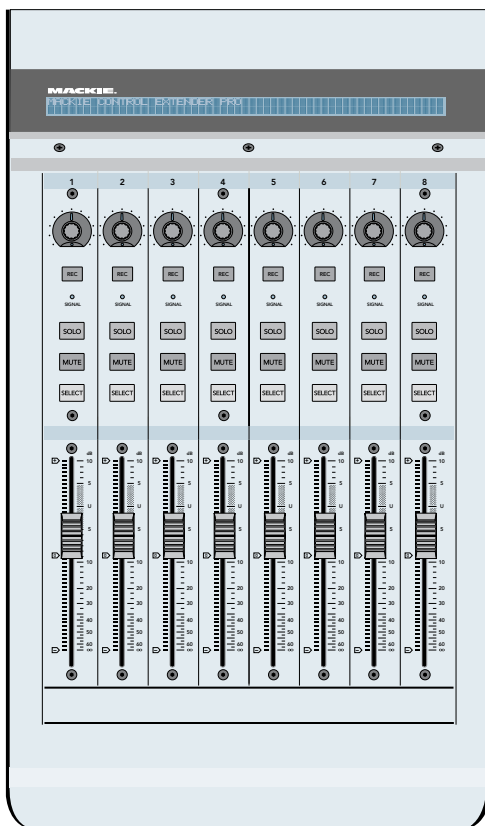

Eight Channel Master Control Surface
and Eight Channel Extender for Digital Audio Workstations

MACKIE.®

<div style="display: inline-block; text-align: center; background-color: black; color: white; padding: 2px 10px; font-weight: bold; font-size: 1.2em;">CAUTION AVIS</div>
RISK OF ELECTRIC SHOCK DO NOT OPEN RISQUE DE CHOC ELECTRIQUE NE PAS OUVRIR
CAUTION: TO REDUCE THE RISK OF ELECTRIC SHOCK DO NOT REMOVE COVER (OR BACK) NO USER-SERVICEABLE PARTS INSIDE REFER SERVICING TO QUALIFIED PERSONNEL ATTENTION: POUR EVITER LES RISQUES DE CHOC ELECTRIQUE, NE PAS ENLEVER LE COUVERCLE. AUCUN ENTRETIEN DE PIECES INTERIEURES PAR L'USAGER. CONFIER L'ENTRETIEN AU PERSONNEL QUALIFIE. AVIS: POUR EVITER LES RISQUES D'INCENDIE OU D'ELECTROCUTION, N'EXPOSEZ PAS CET ARTICLE A LA PLUIE OU A L'HUMIDITE



The lightning flash with arrowhead symbol within an equilateral triangle is intended to alert the user to the presence of uninsulated "dangerous voltage" within the product's enclosure, that may be of sufficient magnitude to constitute a risk of electric shock to persons.

Le symbole éclair avec point de flèche à l'intérieur d'un triangle équilatéral est utilisé pour alerter l'utilisateur de la présence à l'intérieur du coffret de "voltage dangereux" non isolé d'ampleur suffisante pour constituer un risque d'électrocution.



The exclamation point within an equilateral triangle is intended to alert the user of the presence of important operating and maintenance (servicing) instructions in the literature accompanying the appliance.

Le point d'exclamation à l'intérieur d'un triangle équilatéral est employé pour alerter les utilisateurs de la présence d'instructions importantes pour le fonctionnement et l'entretien (service) dans le livret d'instruction accompagnant l'appareil.

Important Safety Instructions

1. Read these instructions.
2. Keep these instructions.
3. Heed all warnings.
4. Follow all instructions.
5. Do not use this apparatus near water.
6. Clean only with dry cloth.
7. Do not block any ventilation openings. Install in accordance with the manufacturer's instructions.
8. Do not install near any heat sources such as radiators, heat registers, stoves, or other apparatus (including amplifiers) that produce heat.
9. Do not defeat the safety purpose of the polarized or grounding-type plug. A polarized plug has two blades with one wider than the other. A grounding-type plug has two blades and a third grounding prong. The wide blade or the third prong are provided for your safety. If the provided plug does not fit into your outlet, consult an electrician for replacement of the obsolete outlet.
10. Protect the power cord from being walked on or pinched particularly at plugs, convenience receptacles, and the point where they exit from the apparatus.
11. Only use attachments/accessories specified by the manufacturer.
12. Use only with a cart, stand, tripod, bracket, or table specified by the manufacturer, or sold with the apparatus. When a cart is used, use caution when moving the cart/apparatus combination to avoid injury from tip-over.
13. Unplug this apparatus during lightning storms or when unused for long periods of time.
14. Refer all servicing to qualified service personnel. Servicing is required when the apparatus has been damaged in any way, such as power-supply cord or plug is damaged, liquid has been spilled or objects have fallen into the apparatus, the apparatus has been exposed to rain or moisture, does not operate normally, or has been dropped.

15. This apparatus shall not be exposed to dripping or splashing, and no object filled with liquids, such as vases, shall be placed on the apparatus.
16. The AC adapter is used as the power device and should be protected from damage.
17. This apparatus has been equipped with a rocker-style power switch. This switch is located on the rear panel and should remain readily accessible to the user.
18. This apparatus does not exceed the Class A/Class B (whichever is applicable) limits for radio noise emissions from digital apparatus as set out in the radio interference regulations of the Canadian Department of Communications.

ATTENTION — *Le présent appareil numérique n'émet pas de bruits radioélectriques dépassant les limites applicables aux appareils numériques de class A/de class B (selon le cas) prescrites dans le règlement sur le brouillage radioélectrique édicté par les ministere des communications du Canada.*

FCC Information

NOTE: This equipment has been tested and found to comply with the limits for Class B digital devices, pursuant to Part 15 of the FCC Rules. These limits are designed to provide reasonable protection against harmful interference when the equipment is operated in a commercial installation. This equipment generates, uses, and can radiate radio frequency energy and, if not installed and used in accordance with the instruction manual, may cause harmful interference to radio communications. Operation of this equipment in a residential area is likely to cause harmful interference in which case the user will be required to correct the interference at his own expense.



This product has been tested and complies with the following standards and directives as set forth by the European Union:

- * EN 55022 Radiated and Conducted Emissions
- * EN 55024 Electromagnetic Immunity
- * EN 61000-4-2 Electrostatic Discharge Immunity
- * EN 61000-4-3 RF Electromagnetic Fields Immunity
- * EN 61000-4-4 Electrical Fast Transient/Burst Immunity
- * EN 60950/IEC 950 Electrical Safety Requirements

WARNING — To reduce the risk of fire or electric shock, do not expose this appliance to rain or moisture.



Introduction

Thank you for choosing Mackie for your Digital Audio Workstation (DAW) control solution. Mackie Control Universal Pro (MCU Pro) and Mackie Control Extender Pro (MCE Pro) provide the familiar feel of analog-style mixing to your DAW environment. But they also deliver the most complete feature set and software compatibility of any control surface available today, including USB connectivity.

The labels for the buttons and controls are specific to Apple Logic Pro. Custom lexan overlays are available for other supported DAWs. Some of these are included with your MCU Pro and others you can order from our website (see the list below for supported DAWs and overlays as of this printing).

These overlays fit over the right-hand side of the control surface and correctly label the buttons for the functionality supported by the DAW you are using. Visit our website (www.mackie.com) to see a list of all the currently supported DAWs, and to order an overlay for your particular DAW application.

Your Mackie Control Universal Pro includes a DVD-ROM that contains Tracktion, our easy-to-use Music Production Software for PC or Mac, the perfect companion software for your new Mackie Control Universal Pro. Check our website (www.mackie.com) periodically for Tracktion updates as they become available.

Overlays Included	Overlays Available
Pro Tools (HUI)	Adobe Audition
Steinberg (Cubase/Nuendo)	Propellerhead Reason
MOTU Digital Performer	Ableton Live
Mackie Tracktion	Sony Vegas
Cakewalk SONAR	Soundscape (Mackie Control)
	RML Labs Saw Studio

Software User's Guides

Visit our website to obtain the latest manuals and information for all the currently supported DAW applications (www.mackie.com/products/mcu/mcu_support.html).

Changing Modes

Mackie Control Universal Pro has three different modes of operation:

1. **Mackie Control** (use with Mackie Tracktion, Ableton Live, Cakewalk SONAR, Magix Samplitude and Sequoia, MOTU Digital Performer, Propellerhead Reason, RML Labs Saw Studio, Steinberg Nuendo and Cubase SX, and Adobe Audition [previously Syntrillium Cool Edit Pro]).

2. **Logic Control** (use with Apple Logic [previously Emagic Logic]).
3. **HUI** (use with Digidesign Pro Tools, including TDM, LE, and M Powered versions).

When you first turn on Mackie Control Universal Pro, the display prompts you to select a mode of operation:

- Press Ch. 1 V-Pot to select Mackie Control.
- Press Ch. 4 V-Pot to select HUI.
- Press Ch. 8 V-Pot to select Logic Control.

Once you've made your selection, Mackie Control Universal Pro will automatically boot into your selected mode each time you turn it on.

To change the mode of operation:

1. Turn off the Mackie Control.
2. Hold down both the Ch. 1 and Ch. 2 SELECT buttons while turning on the Mackie Control.
3. The display once again prompts you to select a mode of operation.

Installation

There are two methods for connecting your Mackie Control Universal Pro (MCU Pro) to your computer: USB and MIDI.

Note: The USB method is the preferred method because you have all the MIDI ports on the MCU Pro available. If you use MIDI cables to connect the MCU Pro to your computer (or to an external MIDI interface), the other two MIDI ports (3 and 4) on the MCU Pro are inactive.

Connecting with USB

- Connect the Mackie Control Universal Pro to your computer with a USB cable (see "Hookup 1: USB" on page 4). The USB connection works with both Macintosh and PC platforms and is "plug and play" (no driver installation required!).

Connecting with MIDI

- Connect the Mackie Control Universal Pro to your USB MIDI interface via two MIDI cables (IN and OUT). Use the MIDI 2 (MAIN) MIDI connections on the MCU Pro.
- Connect your MIDI interface to your computer with a USB cable (see "Hookup 2: MIDI" on page 4).

For both methods:

- Connect one end of the external power supply to the MCU Pro, and the other end to an AC power source between 90 VAC and 264 VAC (50–60 Hz).
- Turn on the MCU Pro POWER switch.
- Launch your software program of choice.
- Select your software's console or surface manager set up window.

- Select the Mackie Control in the MIDI device setup section of your DAW application.
- Once the Mackie Control is selected within your software's setup preferences, the unit(s) will be recognized automatically.
- Mackie Control Universal Pro/Mackie Control Extender Pro units can function as a single large console — a "Control Surface Group."
- Go to the MCU Support section on our website (www.mackie.com/products/mcu/mcu_support) for details on using the MCU Pro with your particular application.

To connect one or more Mackie Control Extender Pros:

1. *If you are using the USB method* to connect the MCU Pro to your computer, then the MCU Pro has three sets of MIDI IN/OUT connectors for connecting additional MCE Pro units. Always connect MIDI OUT from one unit to MIDI IN on the next unit (and MIDI IN to MIDI OUT).
2. *If you are using the MIDI method* to connect the MCU Pro to your computer, then you need to connect the MCE Pro to the external USB MIDI interface (the MIDI 3 and MIDI 4 con-

nectors on the MCU Pro are not functional using this method). Connect the MIDI OUT from the MCE Pro to the MIDI IN on the MIDI interface (and MIDI IN to MIDI OUT).

VESA/Omnimount Mounting

The Mackie Control Universal Pro and Mackie Control Extender Pro have holes in the bottom panel for mounting to a standard VESA wall mount or floating arm mount, using 75 mm or 100 mm mounting patterns. These holes accept M4 (4 mm) screws. The length of the screw will vary depending on the thickness of the mounting plate. The screw length is calculated by determining the thickness of the mounting plate and adding 0.25 inches to that for the threads to engage the pemnut in the bottom of the MCU Pro (see figure below).

The MCU Pro weighs 11.8 pounds (5.4 kg) and the MCE Pro weighs 6.9 pounds (3.1 kg), so be sure to select a mounting arm or plate that can support the weight of the unit.



Many VESA mounts are designed for video monitors, and the mounting plate is perpendicular to your desktop surface. Since you most likely do not want the MCU Pro to be mounted perpendicular to your desktop, make sure your VESA mount is flexible enough so if it can be properly adjusted for your working space.

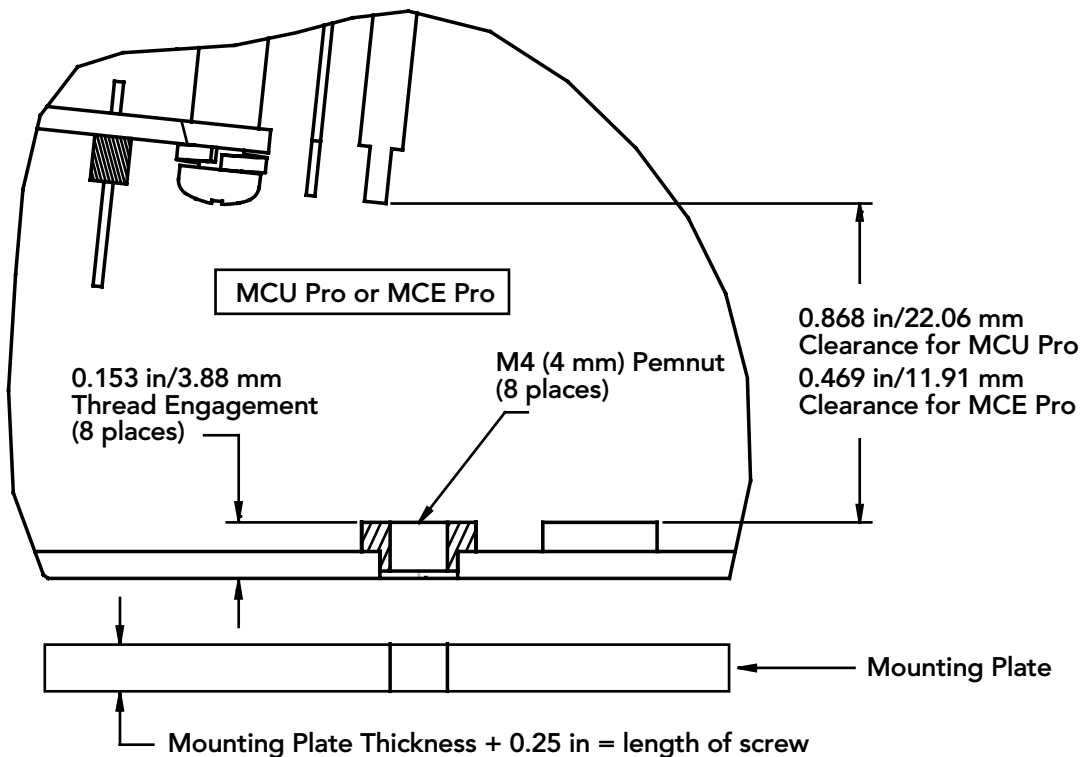

Hookup Diagrams

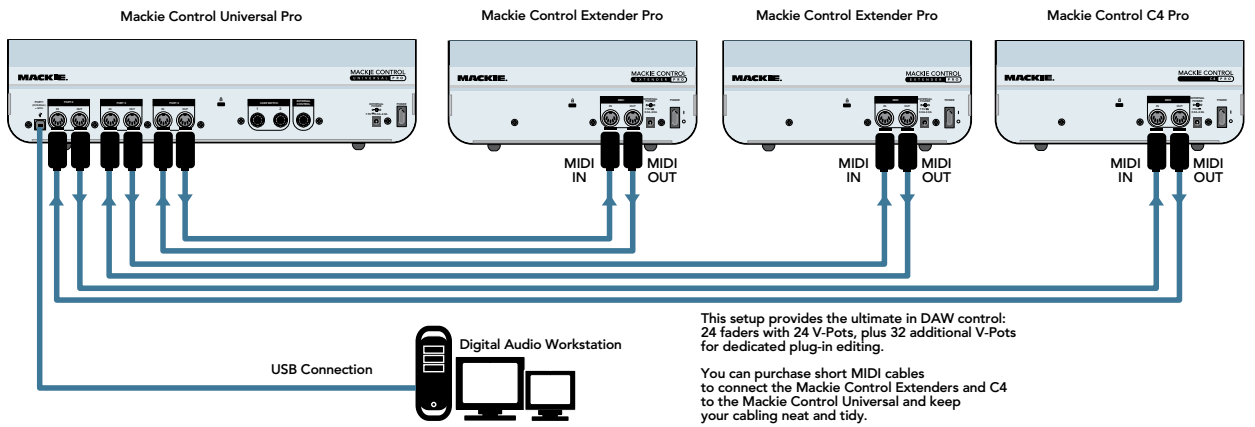

Hookup 1: USB

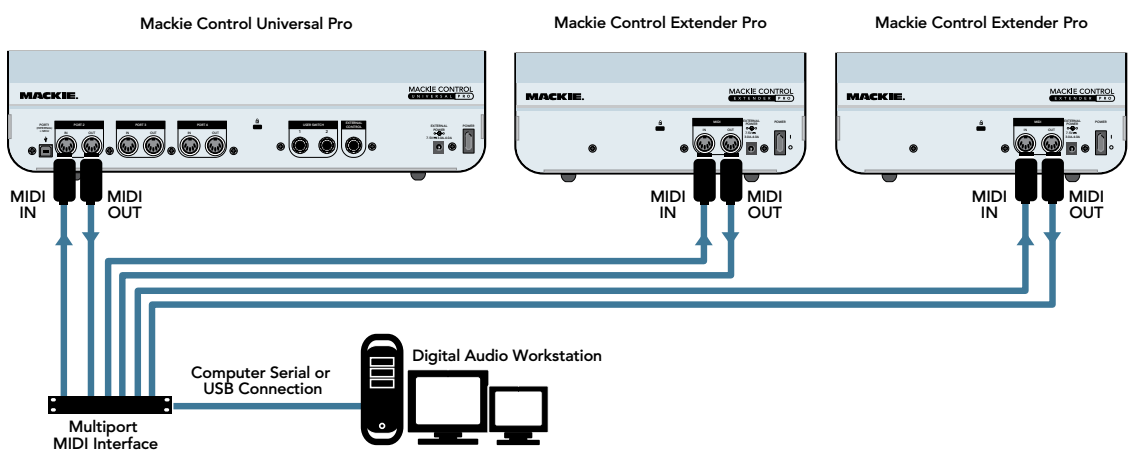

Hookup 2: MIDI

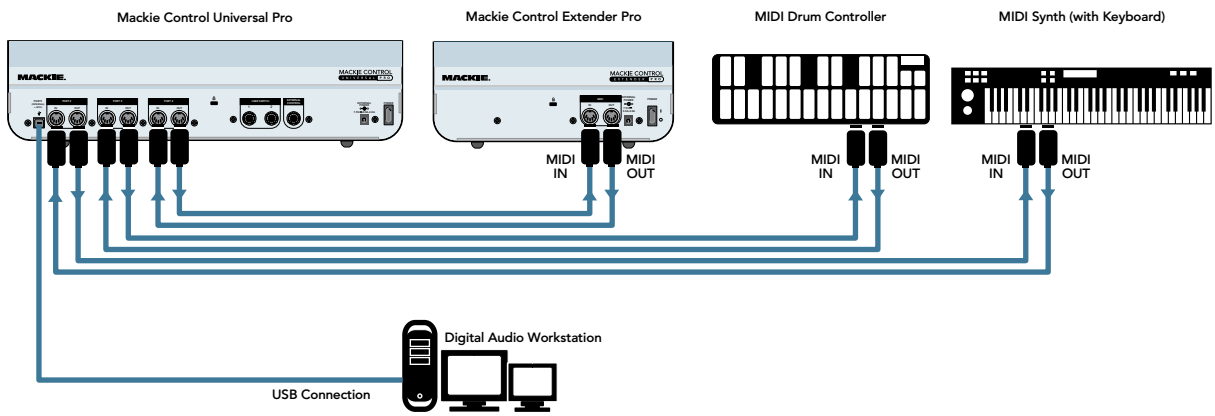

Hookup 3: With Multiple MIDI Devices

Using the Mackie Control Universal Pro

Although the functions of the knobs and buttons on the MCU Pro will vary depending on which software application you are using it with, this section provides an overview of the control surface and a general explanation of what it can do.

Channel Strip

1. Touch-Sensitive Faders

These 100 mm optical, touch-sensitive, motorized faders are used to control the channel's levels, aux returns, MIDI tracks, and master fader levels. The eight faders move relative to the activity of the currently selected bank of on-screen faders.

2. SELECT

This button selects the corresponding channel for channel-based editing or assignment commands.

3. MUTE

The MUTE button turns off the corresponding channel's output signal.

4. SOLO

Pushing a SOLO button isolates that channel's output signal to the mix bus in the DAW application.

Note: When one or more SOLO buttons are active, the RUDE SOLO LED next to the Time Display lights to let you know that one or more channels are soloed.

5. SIGNAL

This LED illuminates when a signal is present in the corresponding channel.

6. REC

This button arms or disables the corresponding track for recording.

7. V-Pot

The V-Pots serve a dual function on the Mackie Control, acting as a push-button and a rotary control. When a V-Pot is pressed, it may be used to change modes of operation or to change what appears in the display above the channel strips.

When a V-Pot is rotated, depending on its assigned function, it can be used to adjust a channel's pan, send level, or plug-in parameters.

The collar surrounding the V-Pot lights up to indicate the relative position of the rotation without having to look at your computer.

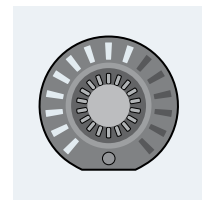

8. Scribble Strip

This backlit LCD above the channel strips displays track names, plug-in parameters, and other information depending on the channel strips current mode of operation.

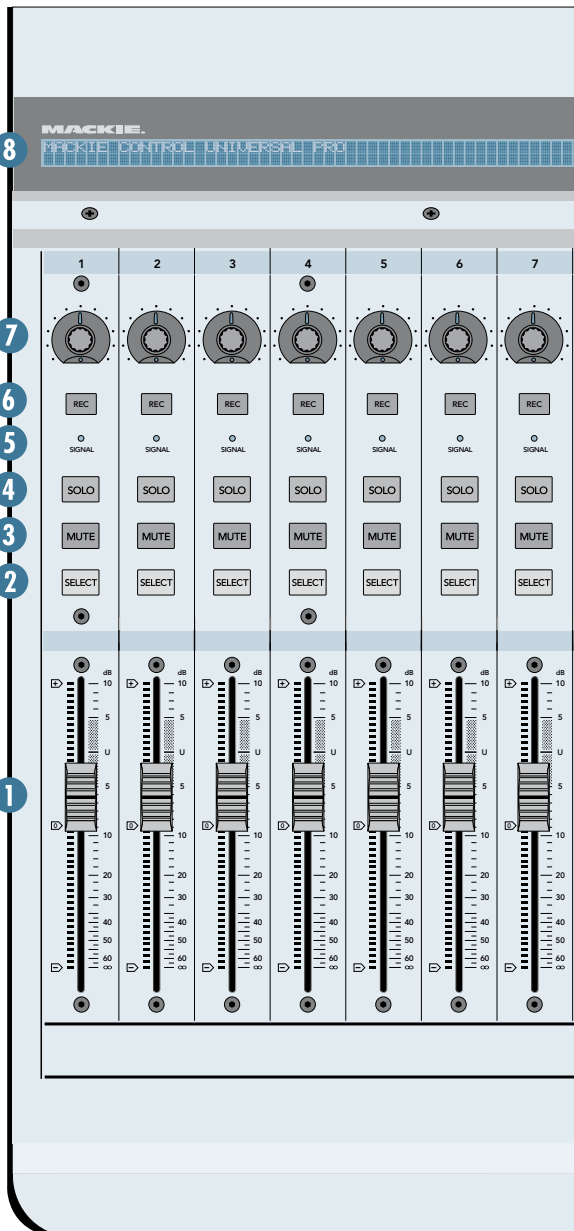

Master Section

9. V-POT ASSIGN

These six buttons are used to assign different functions to the V-Pots. These usually include Pan, Aux Send, EQ, Plug-In Effects, and Track level.

10. BANKS and CHANNELS

Pressing the left or right BANK button jumps over to the next adjacent eight channels on either the left or right side of the current location.

- If one or more Mackie Control Extenders are present, the BANK buttons jump over by 8 times the number of devices present. For example, if two Mackie Control Extenders are present in addition to the Mackie Control, the BANK buttons will jump 8 x 3 or 24 channels at a time.
- Pressing the left or right CHANNEL button jumps over to the next adjacent channel on either the left or right side of the current location.

11. Function Select

The function of these buttons vary, depending on the DAW application you are using. Place the overlay for your particular DAW application over this section to provide the correct labeling for these buttons, and refer to the documentation for the DAW application that describes how it operates with Mackie Control.

12. Transport

These standard transport control buttons are fairly universal in their operation: Rewind, Fast Forward, Stop, Play, and Record.

13. Jog/Shuttle Wheel

Use the button to toggle between Jog and Shuttle functions for the large wheel. Use the wheel for editing audio in your DAW application.

14. Zoom and Navigation buttons

These four arrow buttons and the zoom button are used to navigate around the graphic editor in your DAW application.

15. Time Display

This display shows the time location of your project in either SMPTE or BBT format.

16. Mode LED

Indicates the current mode of operation for the channel strips.

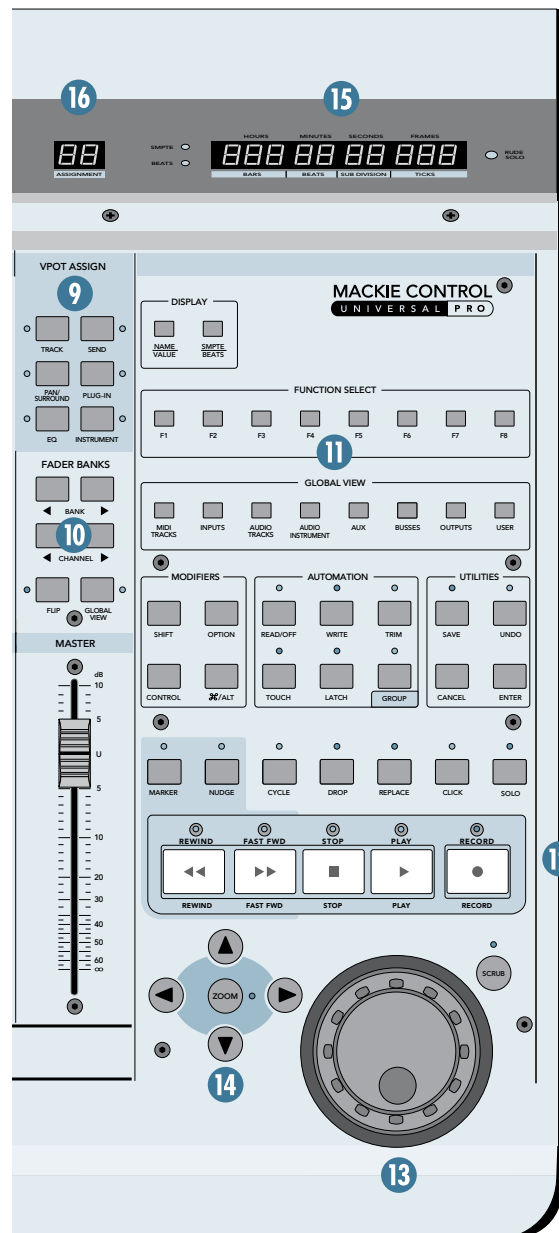

Rear Panel

17. USB Port

This is the USB connection between the MCU Pro and the host computer. Use the USB cable provided to connect this port to a USB port on your computer.



Note: When the MCU Pro is connected to your computer with the USB connection, it appears as a 4x4 MIDI device to your computer and your DAW application. The MCU Pro control surface appears as Port 1 in the DAW application. Ports 2-4 correspond to the MIDI Port 2-4 connections on the MCU Pro.

18. PORT 2

These are standard 5-pin MIDI input and output connectors. Connect this to the MIDI IN/OUT ports on your MIDI-equipped device (MIDI IN to MIDI OUT and vice-versa). This appears as MIDI Port 2 in your DAW application.

19. PORT 3

These are standard 5-pin MIDI input and output connectors. Connect this to the MIDI IN/OUT ports on your MIDI-equipped device (MIDI IN to MIDI OUT and vice-versa). This appears as MIDI Port 3 in your DAW application.

20. PORT 4

These are standard 5-pin MIDI input and output connectors. Connect this to the MIDI IN/OUT ports on your MIDI-equipped device (MIDI IN to MIDI OUT and vice-versa). This appears as MIDI Port 4 in your DAW application.

21. USER SWITCH 1 and 2

These are provided for connecting a momentary footswitch to the MCU Pro, which can be used to control functions such as Play/Stop, Rec Ready, Drop In/Out, etc. These functions are usually user-configurable in the DAW application.

22. EXTERNAL CONTROL

This can be used to connect a variable control, like a potentiometer, to control functions such as Master Volume, as determined by the DAW application.

23. Power Connector

This is where you connect the supplied external AC power supply to provide power to the MCU Pro.

The AC power supply provided with your MCU Pro is a universal power supply, so it can be connected to an AC power source between 90 VAC and 264 VAC (50–60 Hz).

24. Power Switch

This turns the power to the MCU Pro on and off.

25. Kensington Lock

To help prevent theft, the MCU Pro and MCE Pro have a security slot designed to fit the popular Kensington security locks. A variety of models are available from their website at www.kensington.com.

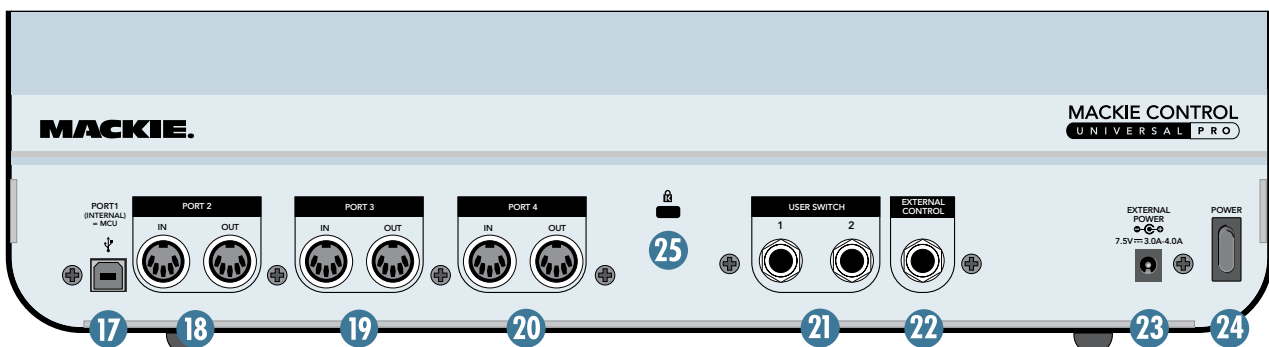

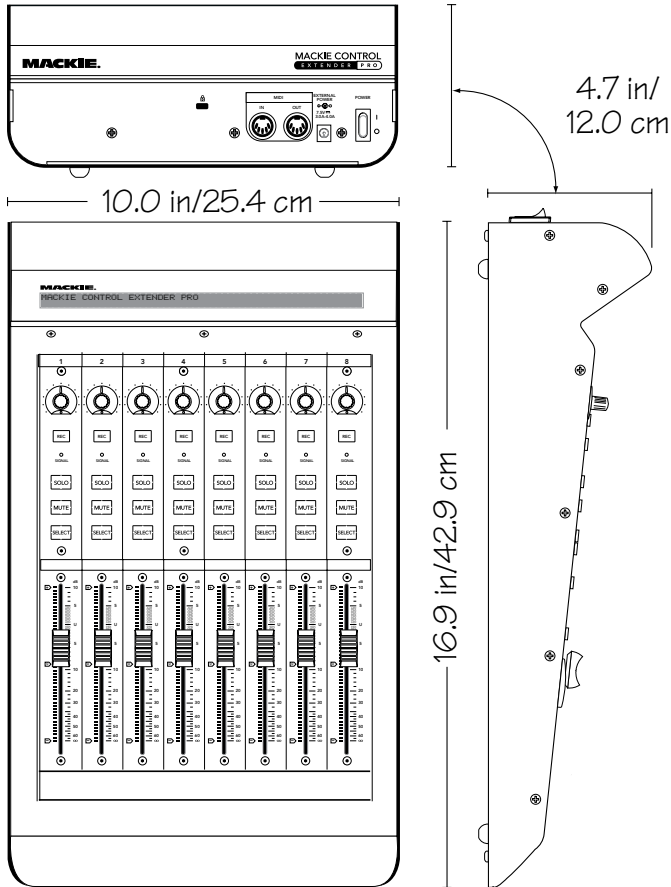

MACKIE CONTROL EXTENDER PRO WEIGHT 6.9 lbs/ 3.1 kg

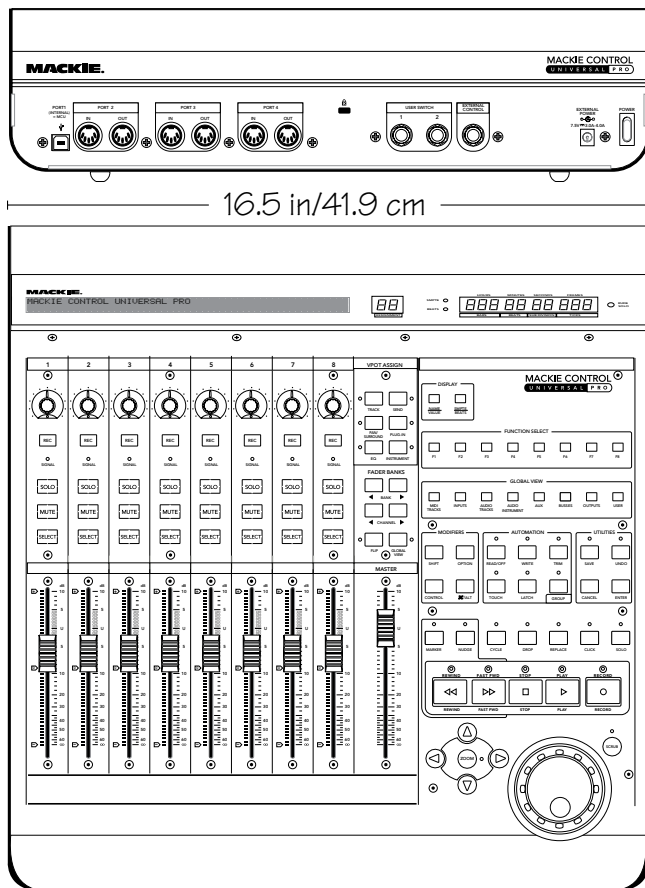

MACKIE CONTROL UNIVERSAL PRO WEIGHT 11.8 lbs/ 5.4 kg

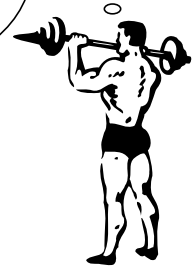

Service

If you think your Mackie Control Universal Pro or Mackie Control Extender Pro has a problem, please do everything you can to confirm it before calling for service. Visit the Support section of our website (www.mackie.com/support) where you will find lots of useful information such as FAQs, documentation, and user forums. You may find the answer to the problem without having to send your Mackie Control away.

If the problem is related to setting up and using Mackie Control with your DAW software, contact your software manufacturer's technical support.

If you are absolutely, positively sure it is a hardware related problem, then go to the repair section next for further instructions.

Repair

Service for Mackie products purchased in the USA is available at a factory-authorized service center. Service for Mackie products living outside the United States can be obtained through local dealers or distributors.

If your Mackie Control Universal Pro or Mackie Control Extender Pro needs service, and it lives in the United States, follow these instructions:

1. Call Tech Support at 1-800-898-3211, 7 am to 5 pm PST, to explain the problem and obtain a Service Request Number. Have your Mackie Control Universal Pro or Mackie Control Extender Pro serial number ready. *You must have a Service Request Number before you can obtain service at the factory.*
2. Keep this quick-start guide. We don't need it to repair the controller.
3. Pack the controller in its original package, including endcaps and box. *This is very important.* When you call for the Service Request Number, please let Tech Support know if you need new packaging. *Mackie is not responsible for any damage that occurs due to non-factory packaging.*

Please write your serial number here for future reference (i.e., insurance claims, tech support, return authorization, etc.)

Purchased at:

Date of purchase:

4. Include a legible note stating your name, shipping address (no P.O. boxes), daytime phone number, Service Request Number, and a detailed description of the problem, including how we can duplicate it.
5. Write the Service Request Number in **BIG PRINT** on top of the box. Units sent without the Service Request Number will be refused.
6. Tech Support will tell you where to ship the controller for repair. We suggest insurance for all forms of cartage.
7. You will need to contact the authorized service center for their latest turn-around times when you call for your Service Request Number. The controller must be packaged in its original packing box, and must have the Service Request Number on the box. Once it's repaired, the authorized service center will ship it back prepaid (if it was a warranty repair).

Note: Under the terms of the warranty, you must ship or drop-off the unit to an authorized service center. The return ground shipment is covered for those units deemed by us to be under warranty.

Note: You must have a sales receipt from an Authorized Mackie Dealer to qualify for a warranty repair.

Please read the warranty information on page 11, then either register online at www.mackie.com or complete and return the Product Registration card included with your Mackie Control Universal Pro or Mackie Control Extender Pro.

"Mackie.," the "Running Man" figure, "Mackie Control Universal Pro," and "Mackie Control Extender Pro" are trademarks or registered trademarks of LOUD Technologies Inc. All other brand names mentioned are trademarks or registered trademarks of their respective holders, and are hereby acknowledged.



MACKIE®

MACKIE CONTROL UNIVERSAL PRO and MACKIE CONTROL EXTENDER PRO LIMITED WARRANTY

Please keep your sales receipt in a safe place.

A. LOUD Technologies Inc. warrants all materials, workmanship and proper operation of this product for a period of two years from the original date of purchase. If any defects are found in the materials or workmanship or if the product fails to function properly during the applicable warranty period, LOUD Technologies, at its option, will repair or replace the product. **This warranty applies only to equipment sold and delivered within the U.S. by LOUD Technologies Inc. or its authorized dealers.**

B. Failure to register online or return the product registration card will not void the two-year warranty.

C. Service and repairs of Mackie products are to be performed only at an Authorized Mackie Service Center (see D below). Unauthorized service, repairs, or modifications will void this warranty.

D. To obtain factory-authorized service:

1. Call LOUD Technologies at 800/898-3211, 7 AM to 5 PM Monday through Friday (Pacific Time) to get a Service Request Number. *Products returned without a Service Request Number will be refused.*

2. Pack the product in its original shipping carton. Also include a note explaining exactly how to duplicate the problem, a copy of the sales receipt with price and date showing, and your return street address (no P.O. boxes or route numbers, please!). If we cannot duplicate the problem or establish the starting date of your Limited Warranty, we may, at our option, charge for service time.

3. Ship the product in its original shipping carton, freight prepaid to the authorized service center. The address of your closest authorized service center will be given to you by Technical Support.

IMPORTANT: Make sure that the Service Request Number is plainly written on the shipping carton.

E. LOUD Technologies reserves the right to inspect any products that may be the subject of any warranty claims before repair or replacement is carried out. LOUD Technologies may, at our option, require proof of the original date of purchase in the form of a dated copy of the original dealer's invoice or sales receipt. Final determination of warranty coverage lies solely with LOUD Technologies.

F. Any products returned to one of the LOUD Technologies factory-authorized service centers and deemed eligible for repair or replacement under the terms of this warranty will be repaired or replaced within thirty days of receipt. LOUD Technologies and its authorized service centers may use refurbished parts for repair or replacement of

any product. Products returned to LOUD Technologies that do not meet the terms of this Warranty will be not be repaired unless payment is received for labor, materials, return freight, and insurance. Products repaired under warranty will be returned freight prepaid by LOUD Technologies to any location within the boundaries of the USA.

G. LOUD Technologies warrants all repairs performed for 90 days or for the remainder of the warranty period. This warranty does not extend to damage resulting from improper installation, misuse, neglect or abuse, or to exterior appearance. This warranty is recognized only if the inspection seals and serial number on the unit have not been defaced or removed.

H. LOUD Technologies assumes no responsibility for the quality or timeliness of repairs performed by an authorized service center.

I. This warranty is extended to the original purchaser and to anyone who may subsequently purchase this product within the applicable warranty period. A copy of the original sales receipt is required to obtain warranty repairs.

J. This is your sole warranty. LOUD Technologies does not authorize any third party, including any dealer or sales representative, to assume any liability on behalf of LOUD Technologies or to make any warranty for LOUD Technologies Inc.

K. THE WARRANTY GIVEN ON THIS PAGE IS THE SOLE WARRANTY GIVEN BY LOUD TECHNOLOGIES INC. AND IS IN LIEU OF ALL OTHER WARRANTIES EXPRESS AND IMPLIED, INCLUDING THE WARRANTIES OF MERCHANTABILITY AND FITNESS FOR A PARTICULAR PURPOSE. THE WARRANTY GIVEN ON THIS PAGE SHALL BE STRICTLY LIMITED IN DURATION TO TWO YEARS FROM THE DATE OF ORIGINAL PURCHASE FROM AN AUTHORIZED MACKIE DEALER. UPON EXPIRATION OF THE APPLICABLE WARRANTY PERIOD, LOUD TECHNOLOGIES INC. SHALL HAVE NO FURTHER WARRANTY OBLIGATION OF ANY KIND. LOUD TECHNOLOGIES INC. SHALL NOT BE LIABLE FOR ANY INCIDENTAL, SPECIAL, OR CONSEQUENTIAL DAMAGES THAT MAY RESULT FROM ANY DEFECT IN THE MACKIE PRODUCT OR ANY WARRANTY CLAIM. Some states do not allow exclusion or limitation of incidental, special, or consequential damages or a limitation on how long warranties last, so some of the above limitations and exclusions may not apply to you. This warranty provides specific legal rights and you may have other rights which vary from state to state. and you may have other rights which vary from state to state.

MACKIE®

16220 Wood-Red Road NE • Woodinville, WA 98072 • USA

United States and Canada: 800.898.3211

Europe, Asia, Central and South America: 425.487.4333

Middle East and Africa: 31.20.654.4000

Fax: 425.487.4337 • www.mackie.com

E-mail: sales@mackie.com