

Applications

Chapter 4

Setting Up for a Session

This section of the Digital 8•Bus Owner's Manual provides very application-specific descriptions of some common usages. Follow the checklist format to help ensure everything is set just right for your configuration.

As your skills and knowledge increase, try new techniques. Build a system that's optimized for your specific application.

Listening Environment

In any serious recording or live audio situation, the listening environment is one of the most important considerations. In a recording application, be sure the Digital 8•Bus is connected to excellent reference monitors, like the Mackie HR824's. In addition, set up the system in an acoustically controlled and balanced environment. Avoid a control room with identical dimensions in any direction and set it up with a good mixture of absorption and reflection.

In a live-sound setting, place the console out in the house at a good visual and auditory vantage point. If you're mixing in mono, it's okay to sit in line with one of the speaker clusters. When mixing in stereo or surround, select the best location—typically called the “sweet spot”—to critically assess the entire mix. Eliminate guess work. Maximize efficiency.

Channel Configuration/Planning

This actually has a lot to do with how well any audio experience unfolds. If you know where you're headed with track expectations and instrumentation, you'll be able to make better choices along the way. Plan; plan again; think about it; then, plan some more.

Devise a mock up of the final track sheet before you begin recording. You'll know more about how to get where you want to be.

Power-up Procedure

A well-thought-out power-up procedure saves wear and tear on all your gear. This procedure helps minimize the opportunity for equipment damage while maximizing the chance of success. Refer to Figure 4-1 for a Fast Track Graphic representation of this procedure.

- Amplification system off: power amps or powered monitors**
- Master Fader down**
- Switch Console Power on**
 - The D8B will create a Startup file with default settings if the User-Set Template has not yet been specified.
- Open and load a snapshot or a session (optional)**

Figure 4-1 Power-up Procedure

Follow this procedure for a safe and sure startup routine. Deliberate, well-thought-out procedures help eliminate uncomfortable pauses in a session. They make recording a more enjoyable experience.

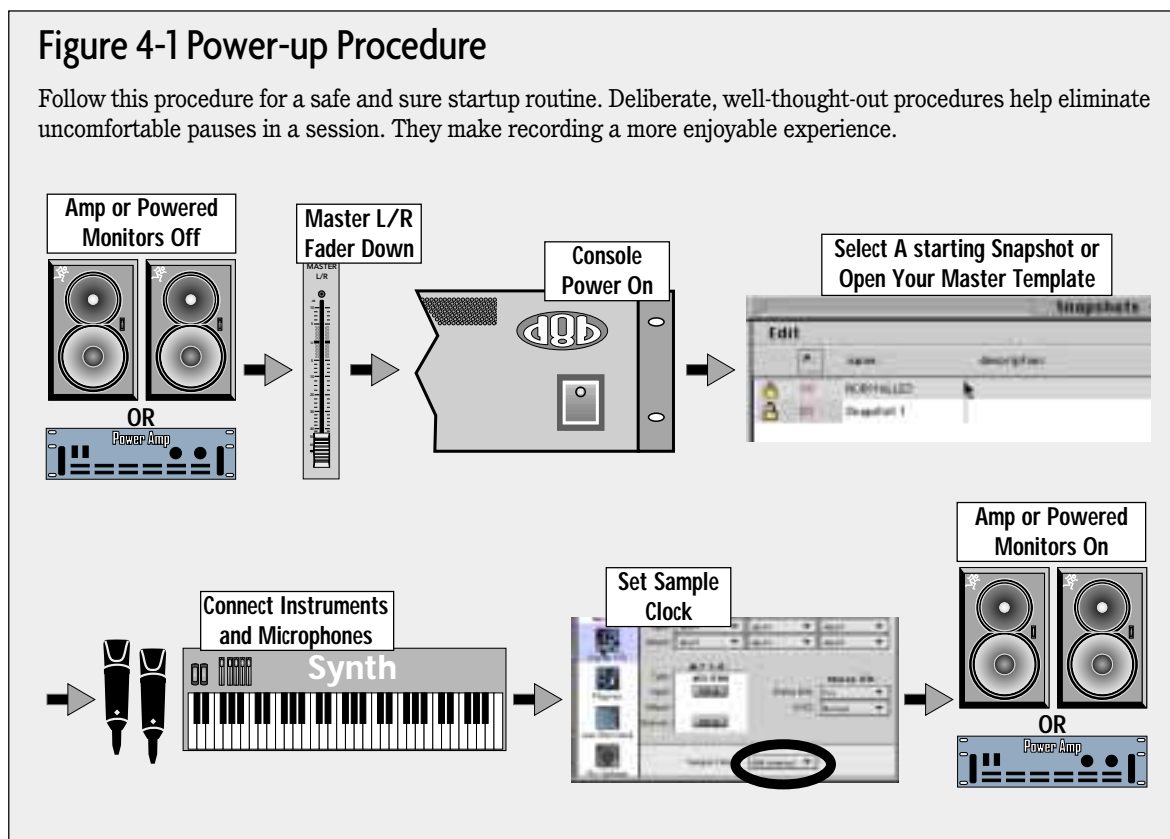

- It's a good idea to keep a snapshot of each working configuration as a starting point: tracking, overdubs, symphony, grunge band, etc.
- ❑ **Connect all mics and instruments**
 - Be sure all channel faders are down.
 - Turn Master Fader down.
 - Turn Speaker level down.
 - ❑ **Set up sample clock**
 - Verify consistent sample rate settings throughout all digital multitrack recording devices.
 - Word clock and digital data transfer connections are very important to the efficiency and functionality of any digital system. Verify them.
 - Most systems work best when the D8B is the Master word clock source. Use the Apogee Clock I/O card to send word clock to slave devices.
 - ❑ **Turn amplification system on**
 - Wait until all other gear is powered up before turning on the monitor system.
 - ❑ **Enjoy the creative process**

Setup Window

The Setup Window is very important to the functionality of the Digital 8•Bus. Its settings determine how the console functions within its own architecture as well as how it interfaces with other digital equipment.

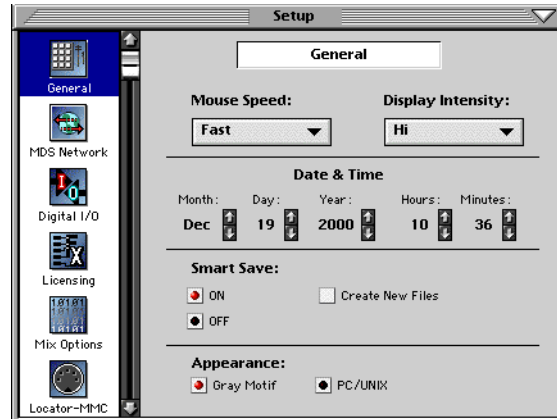

Follow the checklist on the next page to verify that each Setup Window parameter is intentionally set. For specific recommendations for various parameter settings, refer to “The Setup Window” on page 64.

Figure 4-2 Basic Connection for Multitrack Recording

This diagram represents the fundamental connections in a D8B-based multitrack system. Sound sources feed Fader Bank 1 (MIC/LINE); Fader Bank 1 feeds the multitrack inputs via the AIO•8, DIO•8, or ADAT card outputs; the multitrack outputs feed Fader Bank 2 (TAPE) via the AIO•8, DIO•8, or ADAT card inputs; the mix output feeds the control room monitor system, master 2-track recorder, headphones, etc.

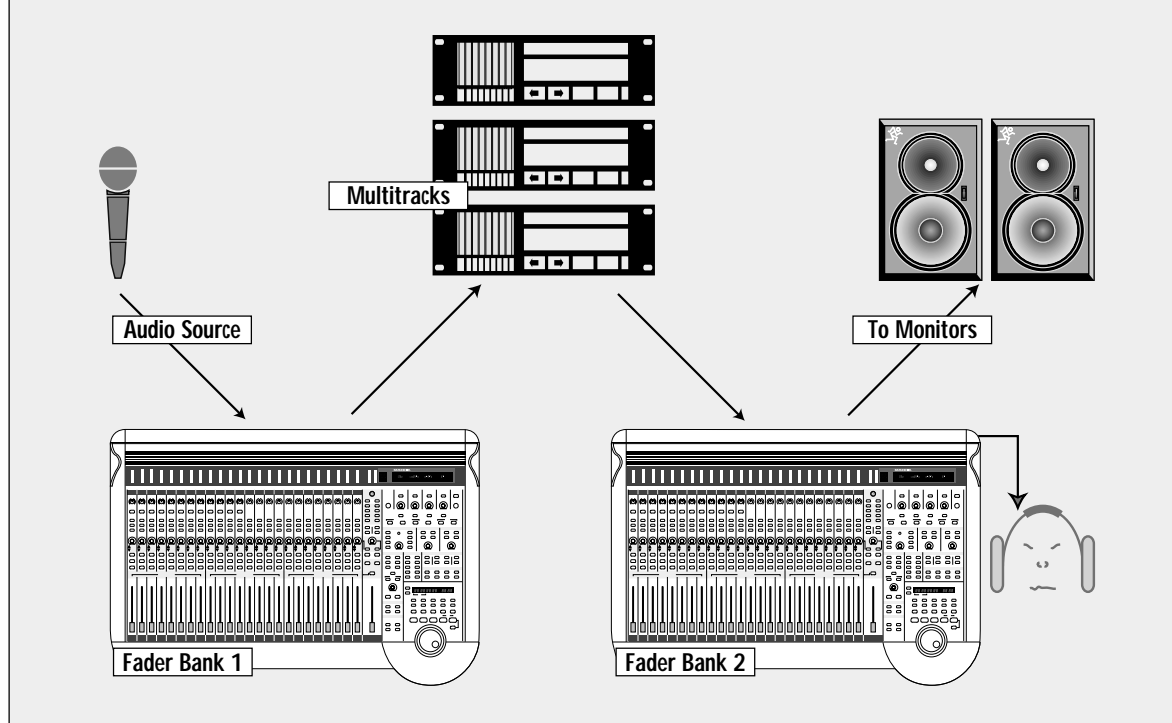

Setup Window settings are automatically stored and are recalled in subsequent boot ups.

- General
 - Mouse Speed
 - Display Intensity
 - Date and Time
 - Smart Save selection
 - Appearance style
- Mackie Digital Systems (MDS) Network
 - Network Channel
 - Mixer Name
 - Alt I/O 1–8 assignments
 - Link Options across the digital network (connected Digital 8•Bus consoles)
- Digital I/O (Tape 1–24)
 - Sample rate
 - Apogee Clock status: Internal/Word Clock
 - Alt 1–8 Type, Inputs, and Outputs
 - Stereo I/O settings
- Licensing
 - Displays authorization status (locked or unlocked) of D8B plug-ins
 - Enables installation and authorization of plug-ins
 - Displays mixer serial number
- Mix Options
 - Surround Mode selection and Bus arming
 - Aux 1–8 global Pre/Post selection
 - Selection of One Button Punch, Record Safe, Use PreRoll, Use Write Ready, Write Flyback, MIDI Snapshots, Solo Latch, Link Speakers, and Faders to Tape
 - Fader Calibration
- Locator-MMC
 - MIDI File Tempo Map loading and resetting
 - Default Tempo setting
 - Device ID selection
 - Song Offset
 - Pre-Roll time
- FTP Server
 - Choose to allow FTP client
 - Set IP Address, Subnet, and Gateway

Installation and Connection of Optional I/O and Effects Cards

The Input/Output cards are an essential part of the D8B multitrack system. These cards provided up to 24 tape outputs and inputs for use with any common analog and digital formats.

Since the I/O cards are optional and interchangeable, you probably need to install them before you begin creating hit recordings. If you install multiple types of I/O cards, note which slots they're installed in. Making a note of each I/O card type and its exact slot will help avoid subsequent problems.

There are several optional cards available for the Digital 8•Bus which you can install into the card cage in the rear panel of the console. These cards provide additional inputs and outputs for specific applications, or additional digital signal processing power for effects.

AIO•8 (Analog Hookup)

This card provides 8 analog line-level inputs and outputs. Connections are made through two 25-pin D-Sub connectors. You can install this card in any of the Tape In/Out slots, or in the ALT I/O slot.

DIO•8 (Digital Hookup)

This card provides 8 digital inputs and 8 digital outputs. Connections are provided in both ADAT Multichannel Optical Interface and Tascam T/DIF-1 formats. You can install this card in any of the Tape In/Out slots, or in the ALT I/O slot. You can mix any combination of the AIO•8 and DIO•8 cards in the Tape I/O slots to suit your particular application. You can configure the card in the GUI (Setup>Digital I/O) and select the I/O connector you wish to use.

Connections for ADAT

The connection for ADAT is made with a fiber optic cable, sometimes referred to as "lightpipe." This connection provides 8 channels of digital audio. You can purchase this cable from your Alesis dealer, Monster Cable, Hosa, or other cable manufacturer.

Connections for DA-88

The connection for T/DIF-1 is made with a 25-pin D-Sub connector. This connection provides 8 channels of bidirectional digital audio. This connection requires a 25-pin D-sub cable (Tascam Part Number PW-88D).

OPT•8 Card (ADAT Optical)

The inexpensive ADAT optical card functions with any device incorporating the ADAT format digital optical lightpipe. The OPT•8 card configures itself automatically; it doesn't need to be adjusted in the Setup>Digital I/O window. Lightpipe connections between the D8B and the connected record/playback device are clean and efficient.

PDI•8 Card (AES/EBU)

This card provides 8 digital inputs and 8 digital outputs in the AES/EBU standard format. Connection is made through a 25-pin D-Sub connector. You can install this card in any of the Tape In/Out slots, or in the ALT I/O slot.

AES/EBU is a standard two-channel digital protocol used for long balanced cable applications. Thus, each conductor actually transmits two channels of digital audio data.

MFX Effects Card

This card provides two additional DSP engines for running internal effects. The Digital 8•Bus is shipped with one MFX card installed in Slot A. You can install up to three more MFX cards in Slots B, C, and D.

UFX Effects Card

This card provides up to four additional DSP engines for running internal effects. The UFX architecture provides access to the newest and coolest third-party plug-ins, as well as an array of groovy new Mackie plug-ins. The D8B effects card slots accommodate any combination of UFX and MFX cards.

Installation of FX Cards



IMPORTANT: Shut off power to the Digital 8•Bus' Remote CPU before installing or removing cards. Also, install your FX cards in order. For example, put your first FX card in the slot marked "A," your second FX card in slot "B," etc.

1. Loosen the four spring-loaded screws on the blank cover plate to the FX card slot you want to fill.

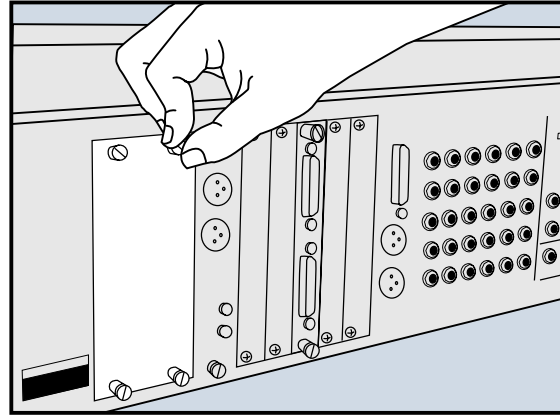

FX Card Cover Plate Removal

2. With your finger in the hole on the FX card (and the components on the circuit board facing to the left), push the card firmly into the white connector slots so it fits snugly. Do not touch any of the circuit board components or solder joints.
3. Replace the cover plate and tighten the screws securely using a slotted screwdriver. **DO NOT OVERTIGHTEN THE SCREWS**, or you run the risk of stripping the threads in the D8B.

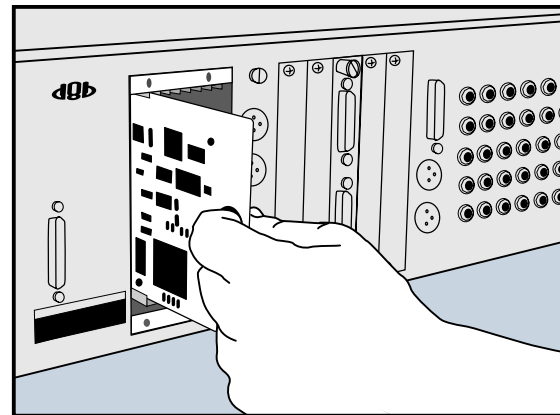

FX Card Installation

Installation of I/O Cards



IMPORTANT: Shut off power to the Digital 8•Bus' Remote CPU before installing or removing cards.

1. Using a #2 Philips screwdriver, unscrew the blank cover plate corresponding to the I/O card slot you want to fill.

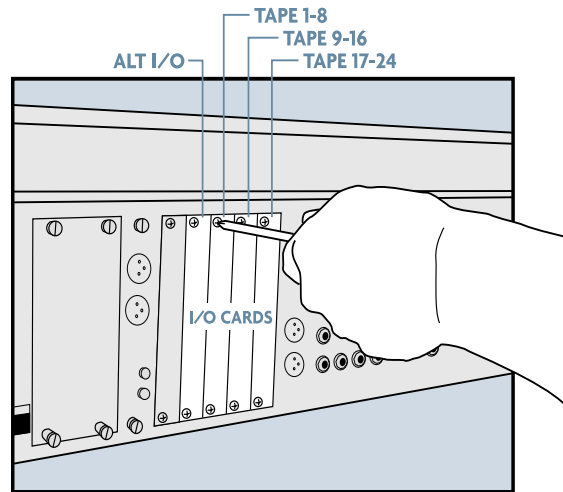

Remove Cover Plate for Tape I/O Card

2. Holding the I/O card so that the components on the green circuit board face to the left (see diagram), line up the card so the top and bottom edges fit into the white guide slots. Do not touch any of the circuit board components or solder joints.
3. Be sure to push the card in all the way—until the front of the I/O card is flush with the back panel of the D8B. This may require a good, solid push, so don't be shy.

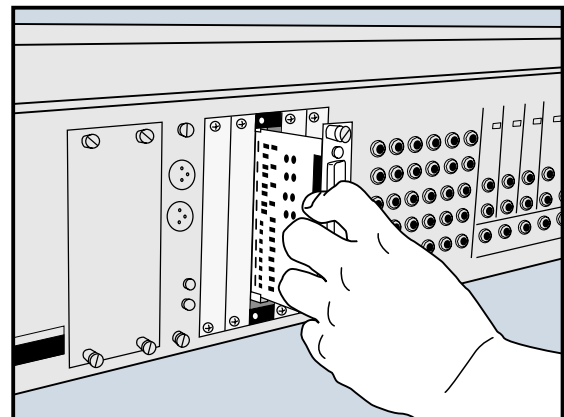

Installing a Tape I/O Card

4. Tighten the spring-loaded screws on the I/O card securely using a slotted screwdriver. **DO NOT OVERTIGHTEN THE SCREWS**, or you run the risk of stripping the threads in the D8B.

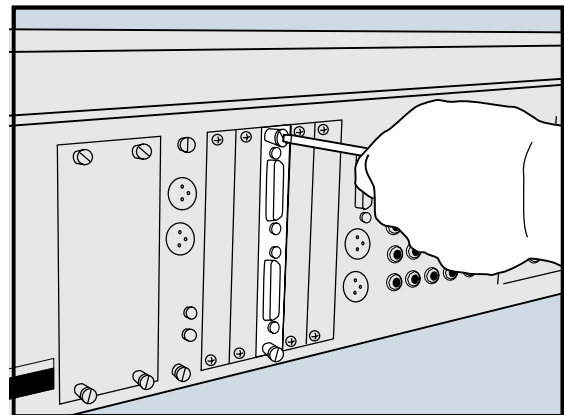

Tighten Screws on Tape I/O Card

Checklist for Basic Operational Functionality

Basic system functionality depends greatly on the accurate selection of a few key items. Work through this checklist to verify console settings. The previous chapters provide an explanation of each item. This checklist simply provides a mental road map to verify proper functionality.

- Control Room selection correct
- Monitor Speaker selection correct

Input source

- Mic/DI
- Line/Instrument

The Fat Channel

- EQ
- Compression
- Gate
- Busing/Routing

Signal Routing

- To L/R
- To Tape
- To Bus

Connecting Analog Multitrack(s)

- Install AIO•8 card(s) into one or more of the D8B TAPE CARD slots. This provides up to 32 tracks of I/O (including the ALT I/O card).
- Using the appropriate cable, connect 25-pin D-sub TAPE OUT connector to the multitrack inputs.
- Using the appropriate cable, connect the multitrack outputs to the 25-pin D-sub TAPE INPUT connector.
- Make sure all connections are tightly secured.

Connecting ADAT (Lightpipe) Multitrack(s)

- Install DIO•8 or OPT•8 card into one or more of the D8B TAPE CARD slots.
- Using a fiber-optic lightpipe cable, connect the D8B Optical output to the ADAT Digital input connector.
- Using a fiber-optic lightpipe cable, connect the ADAT Digital output connector to the D8B optical input.
- If the D8B is to be the slave, the sync source should be connected to the sync card BNC Word Clock input.

Connecting the Analog Multitrack

Simply connect the AIO•8 outputs to an analog console's inputs for up to 32 channels (8 channels per card) of flexible and assignable audio routing, (including the ALT I/O).

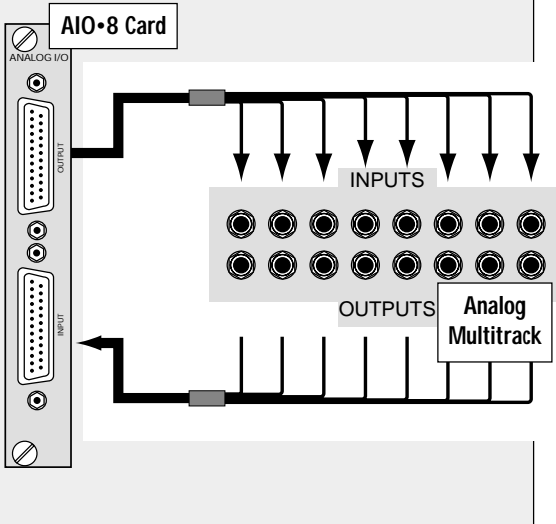

Connecting ADAT Lightpipe

Using two fiber-optic lightpipe cables, simply connect the DIO•8 digital outputs to the ADAT lightpipe inputs, and the ADAT outputs to the DIO•8 inputs, for up to 32 tracks (8 channels per card) of flexible and assignable digital audio (including the ALT I/O).

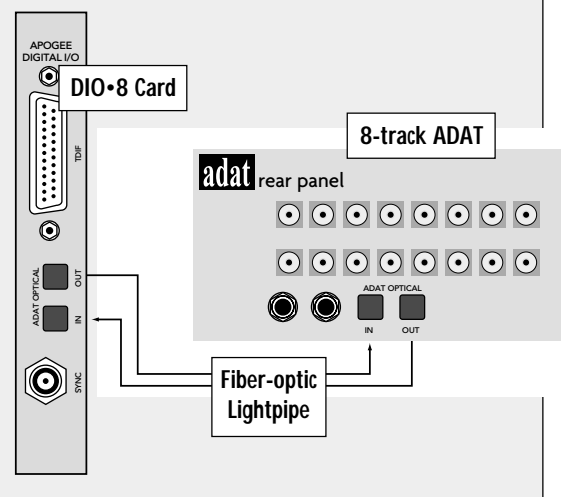

Connecting TASCAM (TDIF) Multitrack(s)

- ❑ Install DIO•8 card into one or more of the D8B TAPE card slots.
- ❑ Using a 25-pin D-sub digital cable (TDIF), connect the D8B Digital I/O connector to the TASCAM MDM (e.g., DA-88) Digital I/O connector.
- ❑ Install BNC clock cable and make sure all connections are tightly secured.
- ❑ If the D8B is to be the slave, the sync source should be connected to the sync card BNC Word Clock input and the D8B Apogee Clock should be set to External in the Setup>Digital I/O window.

Connecting TDIF Digital

Use a 25-pin D-sub digital cable (TDIF) to connect the D8B Digital I/O connector to the TASCAM MDM (e.g., DA-88) Digital I/O connector, for up to 32 tracks (8 channels per card) of flexible and assignable digital audio, including the ALT I/O.

In addition, connect the Sync output from the DIO•8 card to the Word Sync input of the DA-88. This connection indicates use of a DIO•8 Card with firmware version 127v2.

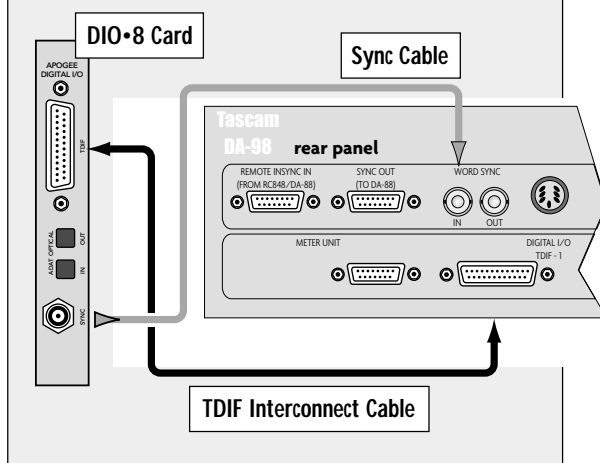

Multitrack Recording

Multitrack recording involves a continuous assessment of signal flow. If you follow a well-planned thought process from the beginning of the signal path to the end, you'll succeed in each audio task.

When multitrack recording using the D8B, it's helpful to visualize the basic signal flow between fader banks. For any multitrack setup, it's important to keep track of the signal path from the console to the multitrack, then from the multitrack back into the console. The illustration below is a review demonstrating an important signal flow concept.

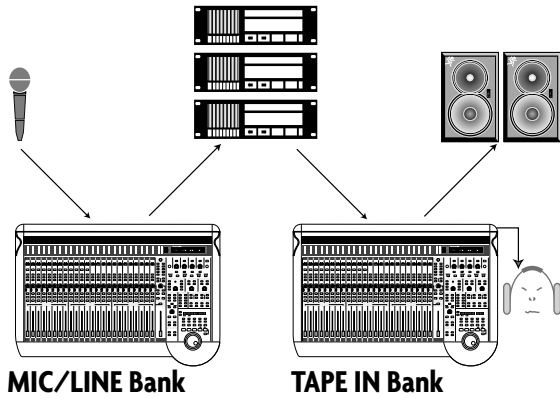

Work your way through this checklist for multitrack recording.

- Connect multitrack ins and outs to D8B.
- Follow basic power-up procedure.
- Select Mic/Line fader bank.

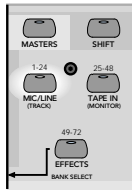

- Press phantom power button on the rear of the console for necessary mic inputs. .

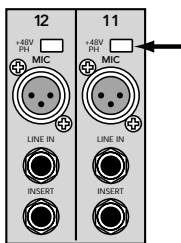

Note: Condenser mics and active DIs use phantom power. Moving coil mics, ribbon mics, and most electronic instruments don't need phantom power.

- Press Mic button on channels using microphone inputs.

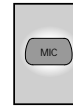

- Configure Auxes for desired Pre/Post status, select Surround Mode, set Mix Options.

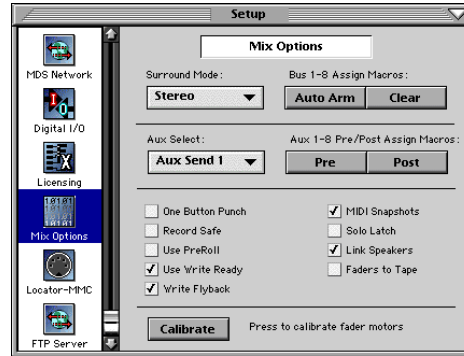

- Test each instrument and mic to verify sufficient level at console input meter.

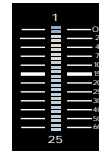

- Adjust input trim for a reading around -15 on the meter.



- Select L/R in the ASSIGNMENT section to confirm Assign lights on for all desired channels, or look on-screen to verify that all necessary channels have L/R button highlighted in Bus Assign section.

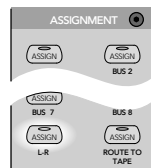

Multitrack Tracking Checklist



- Connect multitrack ins and outs to D8B.
- Follow basic power-up procedure.
- Select Mic/Line fader bank.
- Press phantom power button on the rear of the console for necessary mic inputs.
- Press Mic button on channels using microphone inputs.
- Set pre-fader auxes in Setup Window for monitor use.
- Test each instrument and mic to verify sufficient level at console input meter.
- Adjust input trim for a reading around -15 on the meter.
- Press L/R in the ASSIGNMENT section to confirm Assign lights on for all desired channels. Or, look onscreen to verify all necessary channels have L/R button highlighted in Bus Assign section.
- Set Master Fader to Unity position.
- Turn channel faders up to hear instrument or mic.
- As each channel is verified and audible, press channel mute.
- Assign Fader Bank 1 channels to desired tape track inputs.
- Place tape inputs in record/ready to verify signal at machine. It's typically best to monitor signal from the multitrack rather than from the channel input.
- If levels on the multitrack appear too hot or cold, adjust level with the LEVEL TO TAPE control. Select TRACKING LEVEL. This sets the channel V-Pots to adjust the D8B output level to tape.
- Remove Fader Bank 1 from the L/R mix.
- Adjust control room monitor mix from Tape return in Fader Bank 2.
- Set levels in headphone system for musicians.
- Adjust headphone monitor volume in the PHONES/CUE MIX section.
- Adjust channel aux levels to onboard or outboard effects from Fader Bank 2.
- Verify that Master Output is connected to the mixdown machine.
- Record a pass on the multitrack.
- Play multitrack back.

- Set Master Fader to Unity position.**



- Turn channel faders up to hear instrument or mic.**



- Once each channel is verified and audible, press channel mute.**

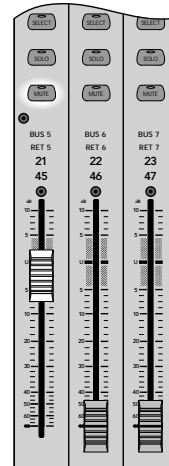

- ❑ Assign MIC/LINE bank channels to desired tape tracks.

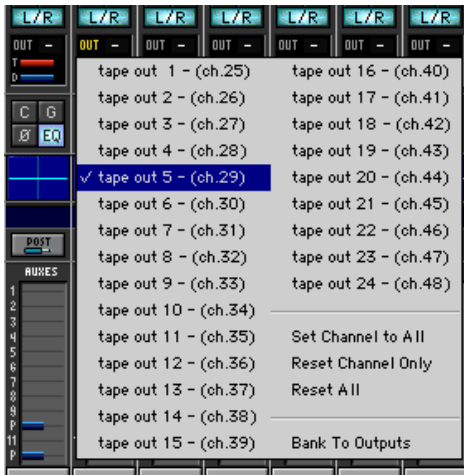

- ❑ If you want to monitor from the multitrack, remove the MIC/LINE Bank from the L/R mix. This has no effect on the output to tape.

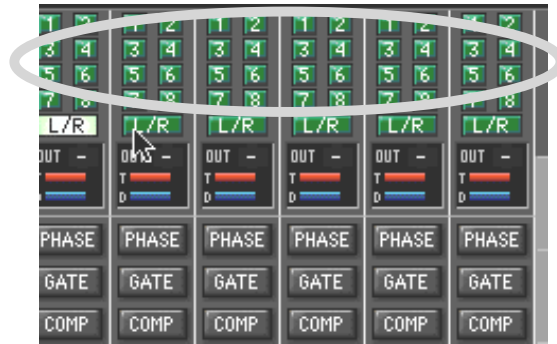

- ❑ Place tape inputs in record/ready to verify signal at machine.

It's typically best to monitor signal from the multitrack rather than from the channel input.

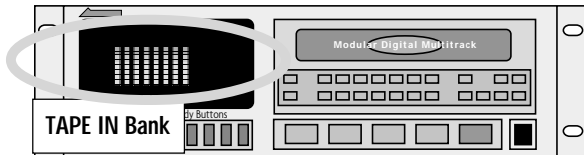

- ❑ Adjust control room monitor mix from TAPE IN Bank. Verify channel assignment to the L/R bus.



- ❑ If levels on the multitrack appear too hot or cold, adjust level with the LEVEL TO TAPE control.

Select TRACKING LEVEL. This sets the channel V-Pots to adjust the D8B output level to tape.

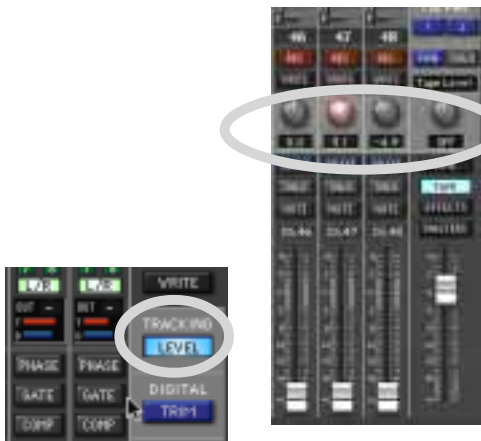

- ❑ Set levels in headphone system for musicians.

Aux 9/10 and 11/12 are perfect for stereo headphone sends. It's often convenient for the musicians to, at first, monitor the L/R mix in the cue section (PHONES/CUE MIX 1 and 2). Once the initial L/R mix is established, copy it to the appropriate cue, then customize for individual monitoring needs.

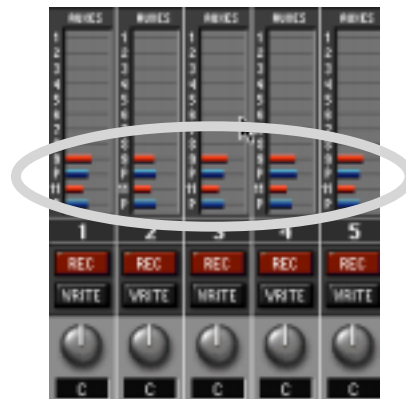

- ❑ **Adjust headphone monitor volume in the PHONES/CUE MIX section.**

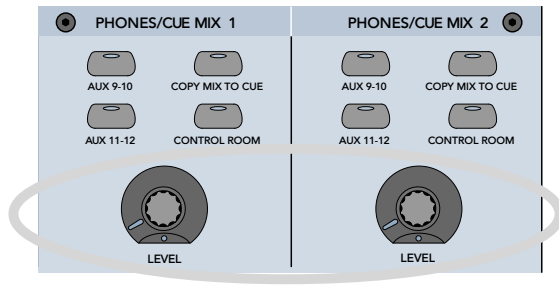

- ❑ **Adjust channel aux levels to onboard or outboard effects from Fader Bank 2 (TAPE IN).**

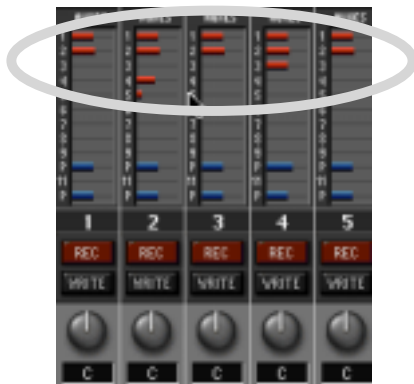

- ❑ **Verify that Master Output is connected to the mixdown machine.**

The mix should be arriving at the mixdown recorder. It's good to check this as part of your tracking process. At the conclusion of a session the artist will probably want to take a rough mix for evaluation—you'll look better if it's already set to go.

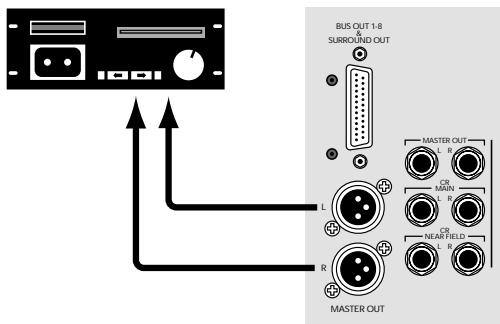

- ❑ **Record a pass on the multitrack**

Play multitrack back—playback should sound identical to tracking and you're ready to print a rough mix.

Sample Tracking Setup

This diagram shows a typical hookup for tracking. Four microphones are connected to channels 1–4 for vocals. Two of them are condenser mics, which require phantom power, so the +48V PH switch is pushed in on those channels. A vocal enhancer is connected to the channel 1 INSERT jack to add a special effect to the lead vocal.

Note: During tracking, dynamics control, like compression and limiting, are often included (insert or onboard) at the beginning of a signal path. Effects, like reverb, delay, and chorus are best left for adjustment during mixdown, or during tracking for monitor use only.

Various instruments are connected to the line inputs of channels 11–14, either directly from their line-level outputs or through effects boxes or direct boxes.

Each input from channels 1–24 is assigned to a tape output, which can be connected to an 8-, 16-, or 24-track recorder—simply use the appropriate I/O card for your setup. You can assign any input (1–48), any return (FX 1–16, RET 1–8), and Bus 1–8 to any unused tape out using the ROUTE TO TAPE button in the Bus Assignment Section (refer to Chapter 2 for review).

Monitoring

Connect the outputs from the recorders to the TAPE Inputs on the Digital 8•Bus. This allows you to monitor the signal as it's being recorded (assuming your recorder has that capability).

To do this:

- Assign channels 25–48 (or whatever channels are being used for tape returns) to the L-R bus.
- In the Control Room Section, assign MASTER L-R as the Control Room Source.

The configuration shown has two external effects devices connected for monitoring. Aux 8 send goes to a digital reverb, which has stereo outputs that feed into the line inputs of channels 19 and 20. Aux 11–12 goes out to a multi-effects stereo processor, which then comes back to the Digital 8•Bus through the line inputs of channels 23 and 24.

In addition, Aux 1 and 2 are routed to the internal FX Card, which processes the signal with whatever plug-in has been downloaded to it. The processed signal is returned to the L-R bus via the FX 1–4 channel strips in Fader Bank 3.

The signal at the CR MAIN, CR NEAR FIELD, and the STUDIO OUT is determined by the Control Room Source selection in the Control Room Section.

You can connect a pair of headphones to the PHONES 1 or 2 jack and monitor the signal there as well. Select CONTROL ROOM as the source in the PHONES/CUE MIX 1 or 2 Section.

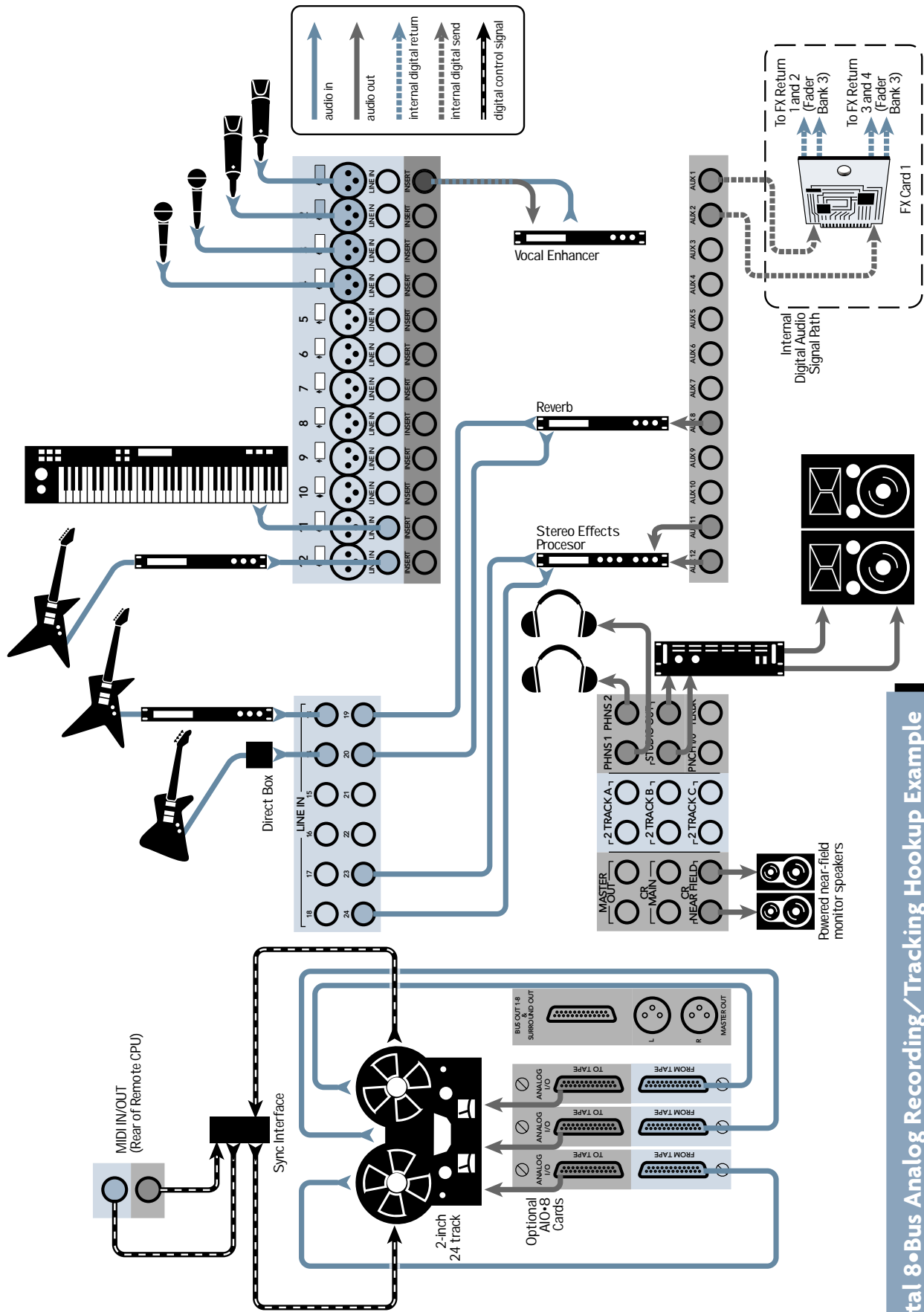

Digital 8-Bus Analog Recording/Tracking Hookup Example

Mixdown Setup

This simple checklist will help get the mix started. Notice that, each time, we follow the signal path from its source to its destination.

- Be sure the multitrack recorder is connected properly to the Tape In card(s).**
- Roll tape to verify signal at TAPE IN Fader Bank.**
- If any track reads excessively hot or cold on the D8B meter bridge, adjust the Digital Trim for a reading around -15 with no peaks (OL).**

Pressing DIGITAL TRIM activates the channel V-Pots as digital input trim adjustments.

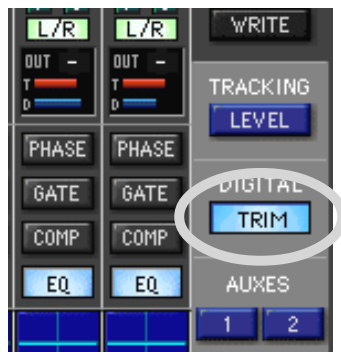

Digital clipping could occur if a signal going into the D8B is too hot. Noise could occur if the signal is too low. Even though the D8B has plenty of headroom and very little noise, it's still a good idea to verify optimum levels.



- With channel faders off, set the Master Fader at Unity.**

- Select Master L/R in the Control Room section and adjust the speaker level to a moderately conservative level (about 9:00).**

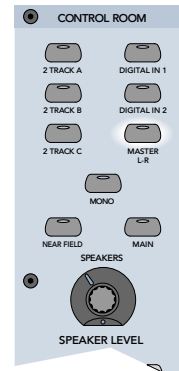

- It's often recommended that you monitor from the output of the mixdown recorder.**

If the outputs from the mixdown recorder are patched into the D8B 2-track or Digital inputs, simply select the mixdown recorder in the Control Room Section (Digital 1, Digital 2, 2 Tracks A–C).

- Adjust the channel faders, dynamics, pan, effects, and EQ for an excellent mix.**
- Record the mix and enjoy the mind-boggling capabilities of the Mackie Digital 8•Bus.**

Sample Mixdown Setup

This sample mixdown setup helps provide ideas for how your mixdown setup might look. Each setup is unique in many ways, yet predictable in many ways.

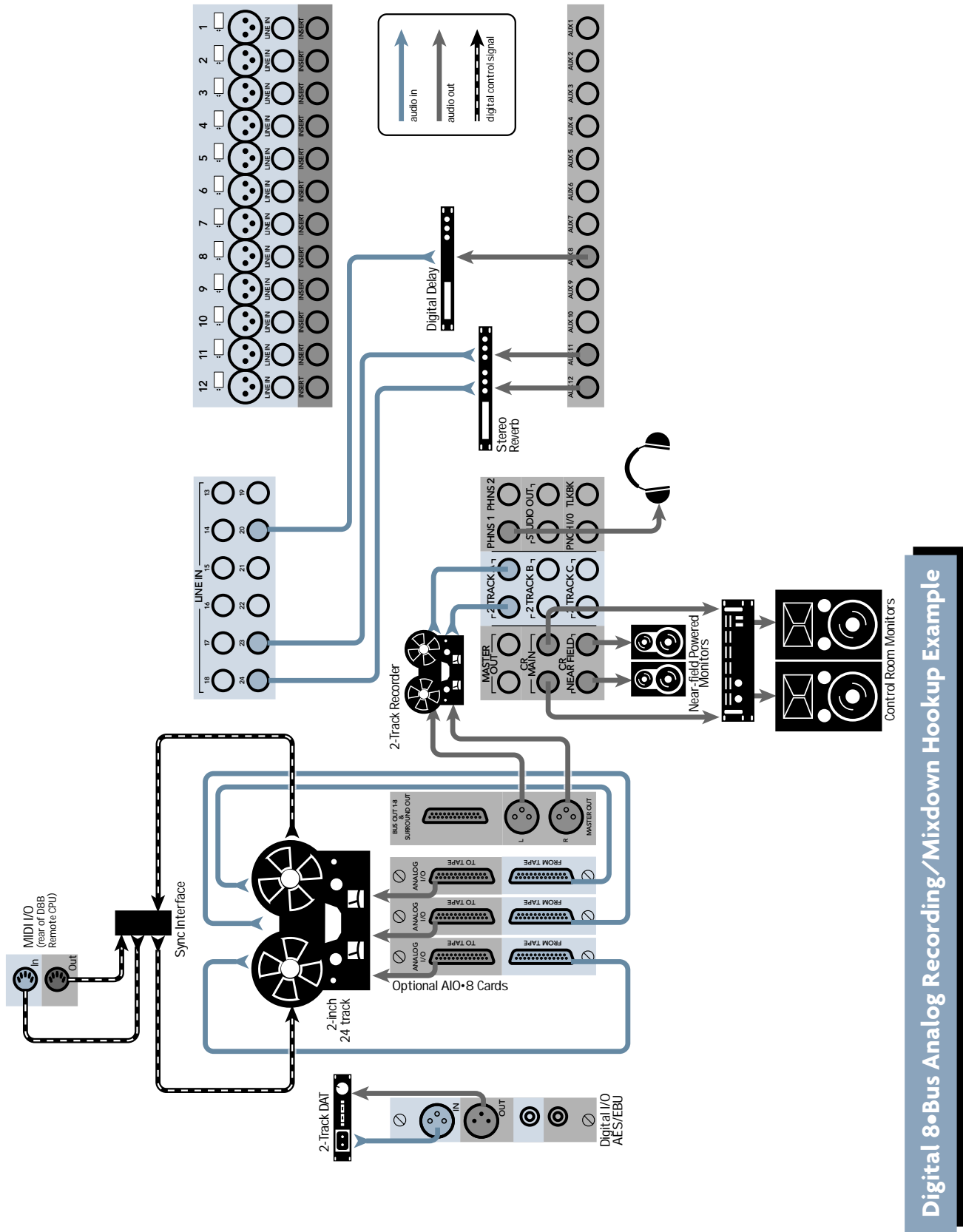

Effects/Plug-ins

MFX/UFX

Before we look at more setup examples, let's cover some quick tips on efficient use of the Digital 8•Bus plug-ins. Follow these easy steps to use the Digital 8•Bus internal plug-ins.



1. Open the Plugin Configuration window (click Plugins in the upper menu bar and select Plugins, or Ctrl+P) and select the Mode (Stereo/Mono), Plugin, and Input that suits your needs for each available slot.

Plugin Configuration			
SLOT	INPUT	PLUGIN	MODE
1	Aux 1	MFX 3.0	N/A
2	Aux 2		
3			
4			
5	Aux 3	VocalStudio	N/A
6	Aux 4		
7			
8		TC Level 1	STEREO
9	Aux 5		
10		Antares Autotune	MONO
11	Aux 6		
12	Aux 7	MD'w Mono EQ	
13	Card D Empty		
14			
15			
16			

2. Click the red 1/4" connector on the lower menu bar to reveal the plug-in selector buttons.

3. Select the plug-in you want to adjust by clicking on its button.

4. Plug-ins are organized in the order of the aux buses they correspond to.

Note: In the plug-in windows, clicking directly on the Effects patch name displays a large pop-up menu of Factory or User patch names, which points to available patches in your working directory's Presets folder. Always save your custom presets to the User Presets folder. Presets saved to the Factory Presets folder could be written over by future plug-in updates. It is still possible to use the up/down arrows to scroll through the patch names.



5. Click on the AUX button in the V-Pot Select Section that corresponds to the plugin you want to use.



6. Use the channel V-Pots to set individual channel send to the selected aux bus.

Note: Alternately, you can click and drag on the horizontal bar in the auxes section at the top of the channel strip to adjust the aux send level.



7. Click and drag on the Master V-Pot to adjust the overall aux send level to the selected effect. You can click on the SOLO button in the Master V-Pot Section to monitor the aux send signal.

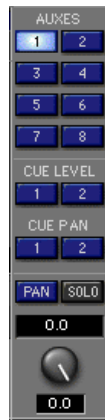

Note: The default setting for each Aux Master level is 0.0 dB. This typically provides sufficient send level and doesn't usually require adjustment.

8. Click on the EFFECTS button to select Fader Bank 3. Click and drag, or physically move, the FX return fader(s) corresponding to the selected effect, to control the amount of processed signal returning to the left and right bus.

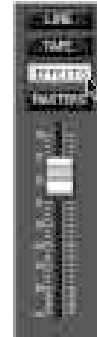

Note: Currently the D8B OS doesn't store effects or any DSP module names. If you create some effects that you really like, we suggest that you name them and store them to disk. For ease of retrieval and organization, create a dedicated effects folder and keep all your working effects patches there.

Don't forget to use the EQ portion of the effects module during patch creation. It certainly can enhance the sound of any given patch.

Setting Up Plug-ins

- Press Ctrl+P on the keyboard (or click Plugins in the upper menu bar and select Plugins) to open the Plugins Configuration window.
- Adjust aux send levels from any applicable bank channels.
- For MFX Plug-ins, each card utilizes two separate mono sends, which are monitored as two separate stereo returns from the MFX plug-in.
- UFX Plug-ins reside in groups of four on each card (2 stereo, 4 mono, or 1 stereo and 2 mono).
- Select the EFFECTS bank to adjust effects return levels at the appropriate faders.
- Pan effects returns left and right in pairs.
- Listen to playback.
- When tracking, it's best to monitor the tape returns.

Note: See the Plug-ins Manuals for specifics on individual plug-in functionality.

Dynamics and EQ Applications

Dynamics and equalization are typically applied in one of three ways:

1. Processing Dynamics and EQ Before Tape

- Select Fader Bank 1 (MIC/LINE).
- Double-click SELECT on the desired channel to open the on-screen Fat Channel.
- Set compression, EQ, or gate.

Since Fader Bank 1 (MIC/LINE) feeds the multitrack inputs, any changes made from that bank are printed to tape.

2. Processing Dynamics and EQ After Tape

- Choose Fader Bank 2 (TAPE IN).
- Double-click SELECT button on the desired channel to open the on-screen Fat Channel.
- Adjust compression, EQ, or gate.

Since TAPE IN Bank receives its feed from the multitrack, Fat Channel changes made here don't affect what is printed to tape.

3. Analog inserts

- Using an insert cable, connect the channel send to the input of an external EQ or dynamics processor.
- Connect the insert cable return side to the external device output.

All channel level adjustments past the insert are dependent on the external device control settings, since the entire channel signal passes through the device.

Dynamic and EQ control should occur only once in any given signal path. Avoid subjecting any signal path to multiple stages of dynamics or EQ processing. As a rule, fewer circuits almost always result in more pristine and accurate audio—even though the D8B signal path is incredibly accurate and transparent.

Many engineers prefer to save all EQ for mixdown, so as to include the least audio manipulation for a more pure sound. Many recordists rough the sound in when recording, using whatever EQ and dynamics they feel the sound needs, then they perfect the audio during mixdown. Many excellent recordings have been the result of these techniques and more. Experiment, and let your ears determine what works best for you.

MIDI and the D8B

MIDI Basics

Your Digital 8•Bus works very well when incorporated in a MIDI network, utilizing a computer referenced to time code.

Be sure to connect the D8B MIDI jacks to your MIDI interface. Within your computer-based MIDI sequencer, set the MIDI channel connected to the D8B to transmit MIDI Time Code (MTC). This is necessary to run automation from a Digital Audio Workstation (DAW).

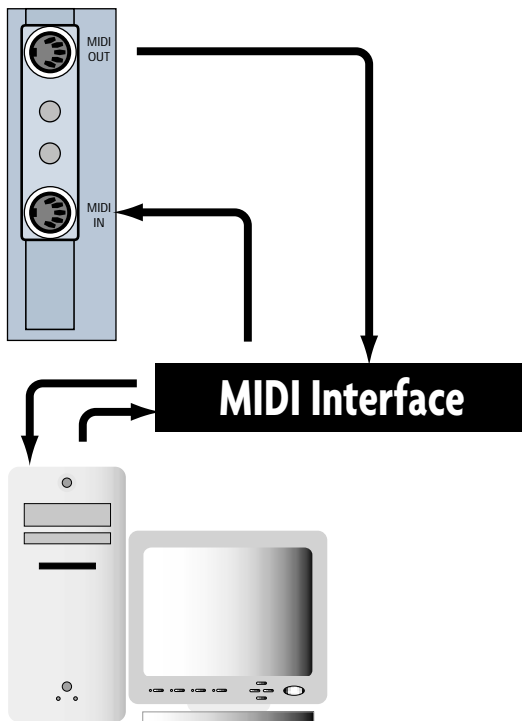

When you don't include a computer in your setup, you need a device like the Alesis BRC to transmit MTC to the D8B for time reference when performing dynamic and snapshot automation.

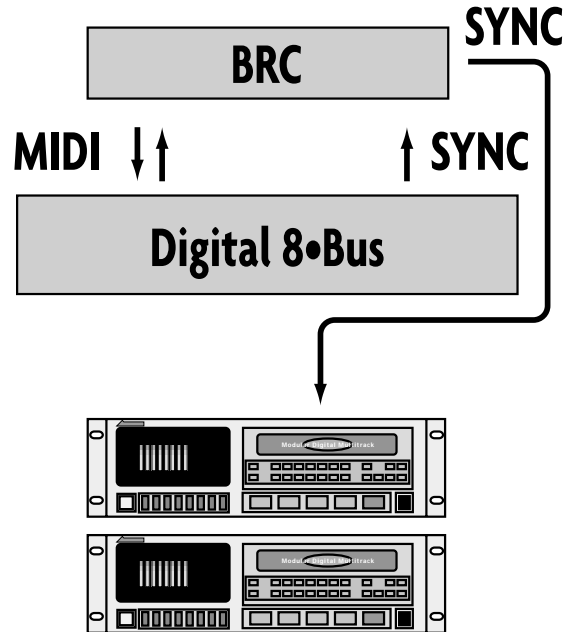

The Digital 8•Bus provides control over some key MIDI parameters. These parameters affect your system's ease of use and efficiency, and should be verified:

- **MMC DEVICE ID:** Some 8-track digital recorders require that you define the device ID numbers used for each recorder in the MIDI Machine Controller. Typically, tracks 1–8 are device 0, tracks 9–16 are device 1, and tracks 17–24 are device 2, so these are the default settings.
- **ONE BUTTON PUNCH:** You can also select whether to press the PLAY and RECORD buttons to enter record mode, or just press the RECORD button (One Button Punch).

Note: We recommend leaving One Button Punch off to provide an extra measure of safety in case you inadvertently press the RECORD button in the Transport Section.

- **MTC OFFSET:** MIDI File Offset can be used to indicate the starting time deviation of a Standard MIDI File (SMF), referenced to absolute time code.
- **TEMPO MAP:** If you use a sequencer in your recording process, you can create a standard MIDI file from the song(s) you've recorded. Copy the tempo map from the SMF to the Digital 8•Bus and "synchronize" the D8B display to the Bars:Beats:Ticks of the sequenced program. SMFs are loaded from the floppy disk drive.

MIDI Snapshots

Once you've developed several snapshots for a mix, they can be recorded into a sequencer for consistent playback.

This feature is set in the Mix Options window, under Setup in the lower menu bar. When enabled:

1) Incoming MIDI program changes (received on any MIDI channel) can recall Snapshots numbered 0–127 on the console.

2) The D8B sends MIDI Program changes on MIDI channel 1 when snapshots are recalled on the console, either via the dynamic automation snapshot track or by manually recalling a snapshot from either the snapshot window or via the front panel.

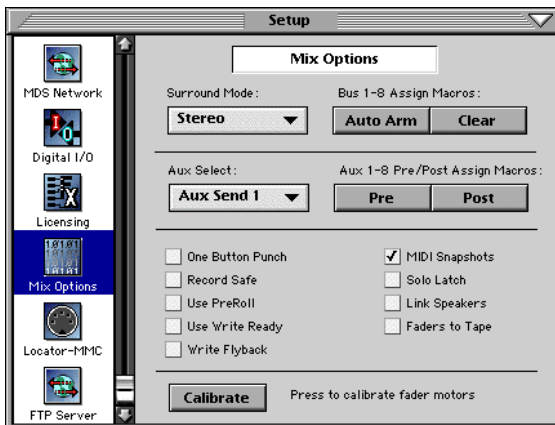

3) Place the sequencer in record on the D8B MIDI channel and cable. While the mix plays, select snapshots at the appropriate time. Each snapshot change is stored as data in the sequence and therefore can be shifted, cut, copied, pasted, etc.

See “The Snapshot Window” on page 69 for information on how to set the program change MIDI channel.

Word Clock and the D8B — The Kitchen Sync

In order for all digital components to function together in unity, they must all move together, sample-by-sample, through the digital data stream.

Word clock is an incredibly important part of digital recording! The concept is simple: If multiple devices are synchronized together via word clock, they progress together through the digital data stream, one sample at a time. This is called sample-accurate sync.

Each system works in reference to one master device. Forty-eight thousand times a second (or whatever the common sample rate is) digital slaves keep track of the word clock status of the master device; they only output the next sample when the master device outputs the next sample.

This type of system provides very accurate synchronization. Incorporating a time reference, like MTC, along with sample accurate sync enables time stamping of data changes, like start-stop time, snapshot placements, real-time automation data, etc. Hence, ultimately flexible and way cool automation capabilities of virtually every control on the Digital 8•Bus! Yahoo!

The optional Clock I/O card for your Digital 8•Bus provides a means to send and receive digital word clock.

This card is necessary:

- When digitally combining the Digital 8•Bus with a computer-based DAW, MDMs, video recorders, etc.
- When the D8B must send or receive word clock other than through ADAT lightpipe or AES/EBU connections.

Sync data can transmit directly through ADAT Lightpipe and AES/EBU connections. However, a complete sync system needs two main ingredients:

- Word clock, sample-accurate sync. This is provided through the Digital 8•Bus optical or AES/EBU connections, and through the optional Clock I/O card.
- Time reference to stamp automation data for accurate playback. This is typically provided through MIDI Time Code (MTC).

Proper Sync Connection

Every digital system needs a master sync source. The D8B prefers to be the master source but will function as a master or slave. Follow these simple steps to help assure a successful digital setup:

- Determine which piece of gear is the master. The master must be able to generate proper word clock that can be read by all other digital equipment.
- Set all digital equipment to the exact same word clock rate—typically 44.1 or 48kHz.
- Connect the word clock output from the master device to the word clock input of the slave devices. Each digital device connected to the digital audio chain must receive a common word clock source, either directly or from a slave.
- It is common procedure to chain word clock through digital devices. The D8B can provide master word clock to a central word clock hub, then the hub can send to multiple digital slaves (DAWs, MDMs, digital effects, etc.).
- Set every slave device to respond to external word clock.
- Draw a digital word clock flow chart for your system. This will help you verify a logical connection scheme. One piece of equipment connected incorrectly can mess up your entire system. Rats!

The following illustration shows a common sync setup, using the Digital 8•Bus as the master word clock source and a hub to distribute to other digitally connected devices.

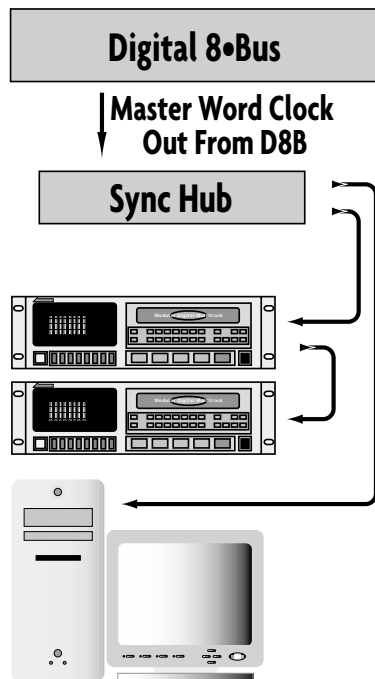

Here are two more sample setups that include the D8B and other digital devices which depend on accurate and solid word sync.

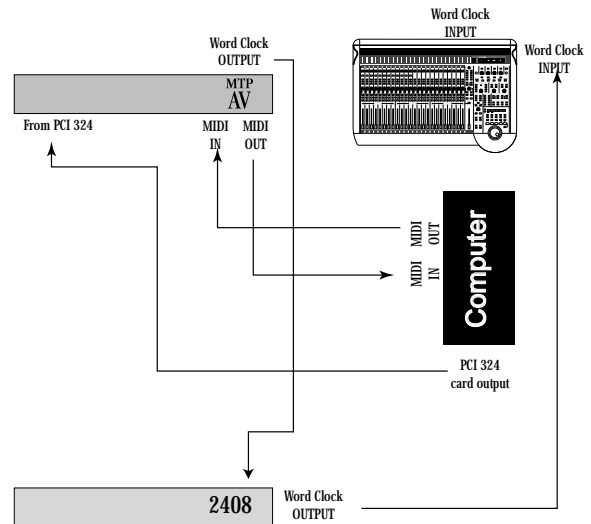
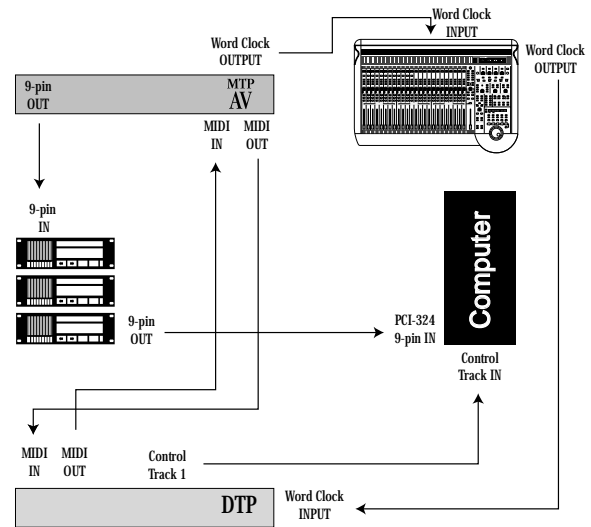

Use expensive, properly impedance-matched cabling! It's worth it!

Note: When using the D8B as the master sync source, always power it up before other digitally connected gear. You'll have a much better day.

Verifying Word Clock Sync Between Devices and the Digital 8•Bus

- When the D8B is set to “Internal” in the Apogee Clock pop-up window, it generates word clock as a master device. All other devices must be connected as slaves.
- If the D8B is slaved properly to a master word clock source, “Locked.” is displayed in the Setup>Digital I/O window next to the Apogee Clock pop-up window and an asterisk (*) flashes in the right-most portion of the control surface VFD.

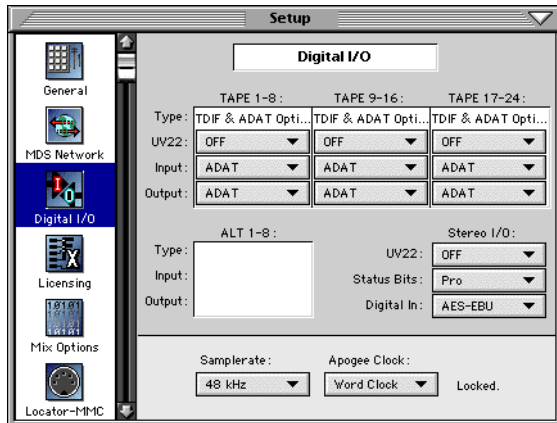

- If the D8B is improperly connected as a slave to the digital network, “Lock Error.” is displayed in the Setup>Digital I/O window next to the Apogee Clock pop-up window and a question mark (?) flashes in the right-most portion of the control surface VFD.

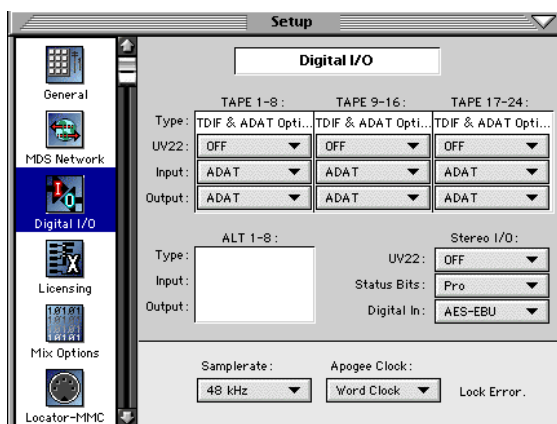

You probably have a bad word clock sync connection if:

- You hear audio but it cuts in and out at regular intervals.
- There is no audio signal at the input of the D8B even though everything seems to be connected properly.
- All meters are full on and you hear a very ugly grating, grinding, static sound.
- When the record/playback device transport is engaged, you see a question mark flashing in the right-most portion of the control surface VFD.

Troubleshooting Word Clock Problems

- Troubleshoot through the system from the master through the slaves. Connect the first two devices and verify their functionality. Once they’re up and running, add the next device, and so on. This is the most efficient manner to check out a system.
- Verify connection, integrity, and quality of all sync cables.
- Verify a consistent sample rate setting on all connected sync devices (all set to the same sample rate—44.1, 48k, etc.)
- Verify that the master sync source word clock output is connected to the word clock input of the slave, and that additional slaves also receive word clock directly from the master device or daisy-chained through connected slaves. Patch word clock out of a connected slave into the word clock input of any other slave.
- Verify that the master device word clock status is set to INTERNAL.
- Verify that all slave devices are set to follow EXTERNAL word clock.
- If the system doesn’t seem to work correctly, you might have an intermittent or broken sync cable. Always use high-quality 75Ω BNC word clock cables.

Dither - To UV22 or Not to UV22: That Is the Question

Digital audio's weakness is its ability to accurately reproduce extremely low-level signals. As the amplitude decreases, there are fewer and fewer bits available to accurately represent the audio wave.

In an analog system the audio simply sinks into the noise floor. Even when covered by noise, the waveform is still audibly intact. In a digital system, low level audio simply becomes inaccurate and sounds really bad. A few bits at the bottom of the amplitude range aren't capable of faithfully converting the analog information to digital, let alone reinterpreting the digital data into analog variations in air pressure.

Dither is a low-level noise that combines with your pristine audio at low levels to help keep enough digital bits active to replicate an accurate waveform throughout the conversion process from digital to analog to digital—go figure that it takes noise to make a system work that has no noise.

UV22 is a very good-sounding type of dither that makes a way for more accurate reconstruction of this low-level audio. The frequency of the UV22 dither noise is lower than the conventional process and therefore provides a more transparent reconstruction.

As a practical application, if your music is to be mastered by someone else in a professional mastering facility, you might not need to use the UV22 process—too much dither can accumulate too much noise. If you're seeing the project through to the end you have three primary options:

- **Don't dither.** If your music is always loud—loud, loud, loud—you might not need to worry about dither because dither really only helps audio quality at low levels. However, if there is a fade out in your song, then of course everything isn't always loud and you'll want to take advantage of the UV22 process to feather the fade out with excellent audio clarity.
- **Dither once.** The conventional approach has been to avoid dithering until the final version is mastered (prepared for duplication). In this case, wait until the final mix is printed to the replication master, then use a Normal UV22 setting on the Stereo I/O in the Setup window. Dither only once on Normal setting; dither noise is cumulative so too much dither equates to senseless noise.

If your music contains only a few low-level passages try using the "Low" setting on the Stereo I/O. "Low" equates to a lower level of noise and, though it might not provide as much smoothing of low-level audio, it might be quite sufficient—and less noise just seems like a better choice wherever appropriate.

- **Dither twice.** If your music contains a wide dynamic range, you might not be able to resist the urge to use dither as you record to the multitrack. In this case, plan to use the UV22 process twice: use it once on the multitrack tracks—on the "Low" setting; use it again on the final printing of the master take—on the "Low" setting. If you use the UV22 process twice, using it on Low setting both times will closely equate to the dither noise resulting from using it once in "Normal" position.

D8B–HDR24/96 Setup

Hookups

This section shows how the D8B is connected to the Mackie HDR24/96. These examples assume that the rest of your studio equipment (monitors, sound sources, outboard processing, etc.) is already connected.

Before you begin, note how the three eight-channel I/O cards are arranged on the HDR24/96 rear panel: 1-8 is on the left, 9-16 is in the center, and 17-24 is on the right. Labeling cables before you begin will make connecting the HDR24/96 to your D8B easier.

The specific hookups for each D8B and HDR24/96 I/O card are shown below.

Analog Hookup to HDR24/96 (AIO•8)

This example describes the analog hookup for the D8B–HDR24/96 combination.

Cables & Hardware

- (3) AIO•8 cards for HDR24/96
- (3) AIO•8 cards for D8B
- (6) DB25 to DB25 analog snakes

Hookup

1. Connect three snakes between the HDR24/96 Inputs (bottom connector) and the corresponding D8B Tape Outputs (top connector).

2. Connect three snakes between the HDR24/96 Outputs (top connector) and the corresponding D8B Tape Inputs (bottom connector).

HDR24/96 Settings

1. Set the **Sample Clock** to **Internal**.
2. Set the **Sample Rate** and **Bit Depth** according to your preference. It is not necessary to set the D8B and HDR24/96 to the same **Sample Rate** since, with analog connections, the sample clocks on the two units are not synchronized.

Console Settings

1. Set the D8B **Sample Rate** to **44.1kHz** or **48kHz**, and set the **Apogee Clock** to **Internal** (in the Digital I/O Setup window).

This example describes the hookup for the D8B console equipped for analog I/O.

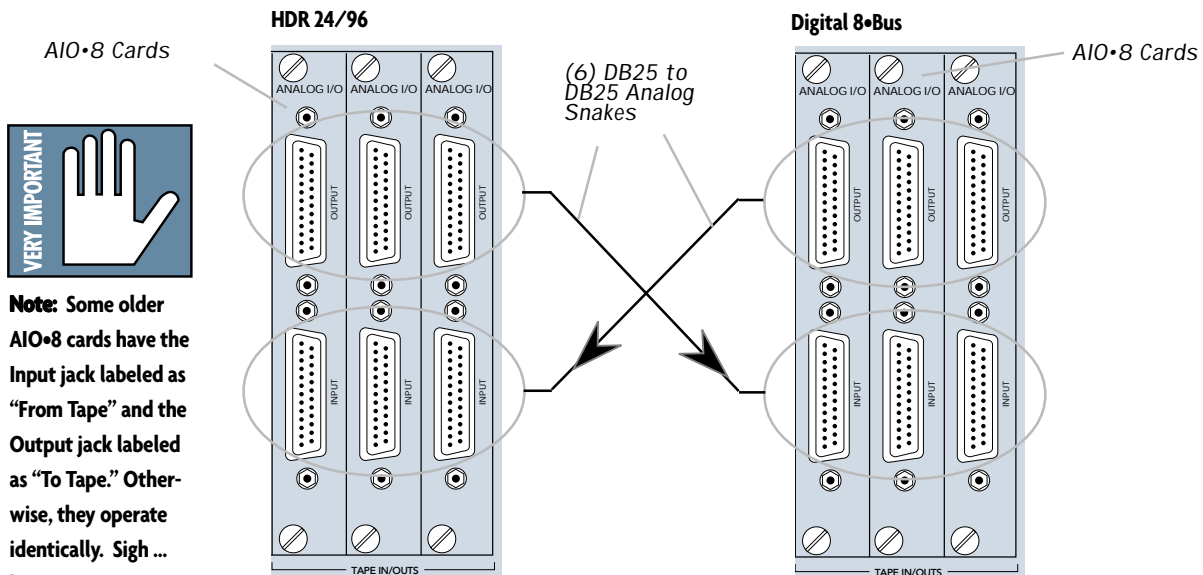

VERY IMPORTANT

Note: Some older AIO•8 cards have the Input jack labeled as “From Tape” and the Output jack labeled as “To Tape.” Otherwise, they operate identically. Sigh ... long story.

TDIF Hookup to HDR24/96 (DIO•8)

Cables & Hardware

- (3) DIO•8 cards for HDR24/96
- (3) DIO•8 cards for D8B
- (1) Clock I/O card for D8B
- (3) TDIF cables
- (1) 75 Ω BNC word clock cable

Hookup

1. Connect the three TDIF cables between the corresponding TDIF jacks on the HDR24/96 and D8B.
2. When TDIF is used, the D8B must have a Clock I/O card installed. To make the D8B the clock master, connect its Word Clock Out (not

DIO•8 Sync out) to the HDR24/96 Word Clock In. To make the HDR24/96 the clock master, connect its Word Clock Out to the D8B Word Clock In.

HDR24/96 Settings

1. Set the Tape Input format for each DIO•8 card to **TDIF**, and the Tape Output format to **TDIF**.
2. If the HDR24/96 is the clock master, set the **Sample Clock** to **Internal**; if it is a clock slave, set it to **Word Clock** and depress the 75 Ω termination switch on the Sync card.
3. Set the **Sample Rate** to 44.1kHz or 48kHz according to your preference.

TDIF Hookup with DIO•8

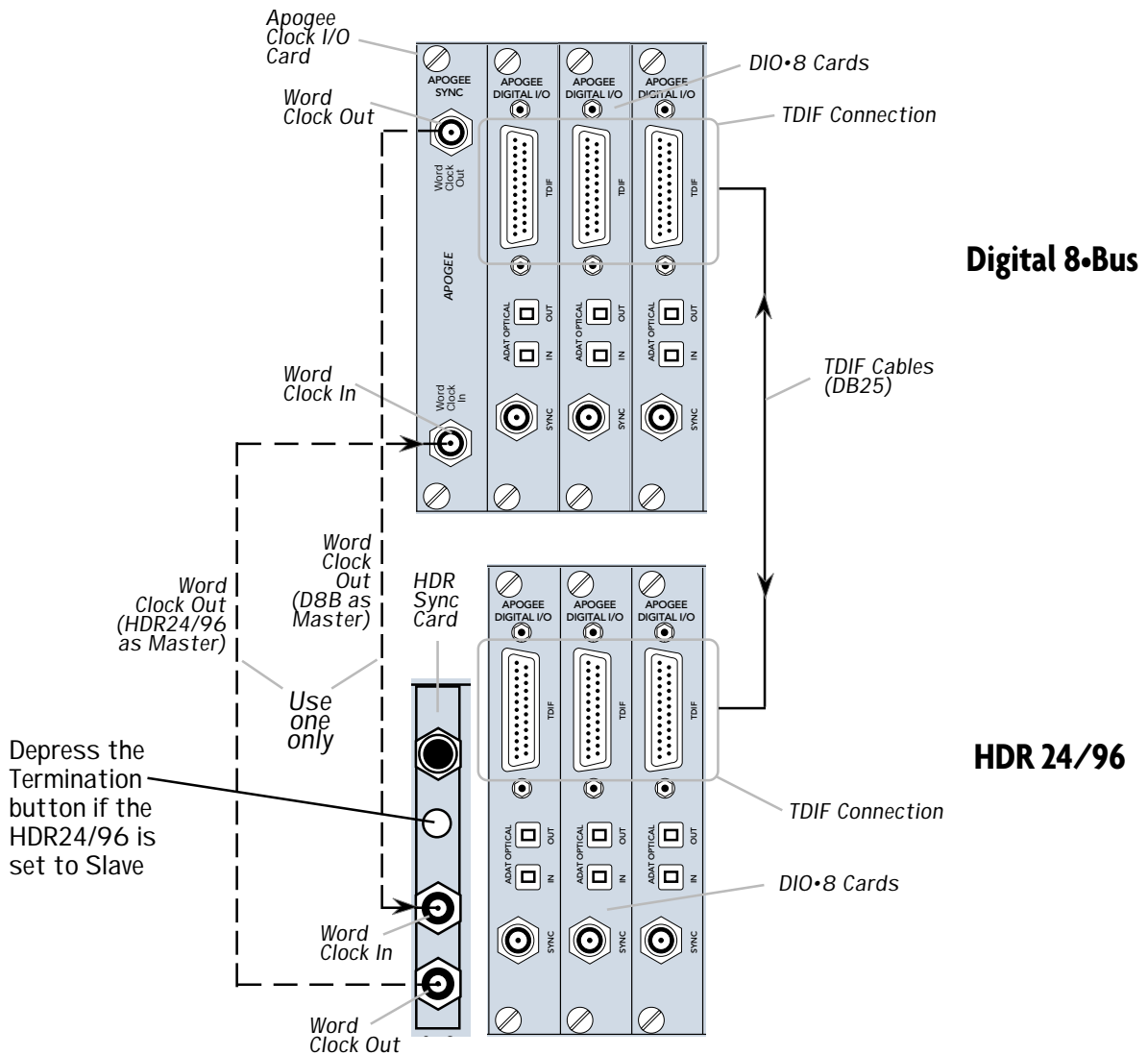

Console Settings

1. Set the Tape Input and Tape Output format for each DIO•8 card to **TDIF**.
2. If the D8B is the clock master, set the **Sample Rate** to either **44.1kHz** or **48kHz**, and set the **Apogee Clock** to **Internal** (in the Digital I/O Setup window). If it is a clock slave, set the **Apogee Clock** to **Word Clock**. Set the **Sample Rate** to match the **Sample Rate** selected on the HDR24/96.

ADAT Optical Hookup to HDR24/96 (DIO•8 or OPT•8)

Cables & Hardware

- (3) DIO•8 or OPT•8 cards for HDR24/96
- (3) DIO•8 or OPT•8 cards for D8B
- (1) Clock I/O card for D8B
- (6) ADAT Optical cables
- (1) 75Ω BNC word clock cable

Hookup

1. Connect three ADAT Optical cables from the HDR24/96 Optical Outputs to the Optical Inputs on the corresponding D8B I/O cards.
2. Connect three ADAT Optical cables from the HDR24/96 Optical Inputs to the Optical Outputs on the corresponding D8B I/O cards.
3. When ADAT Optical is used, the D8B must have a Clock I/O card installed. To make the D8B the clock master, connect its Word Clock Out to the HDR24/96 Word Clock In. To make the HDR24/96 the clock master, connect its Word Clock Out to the D8B Word Clock In.

HDR24/96 Settings

1. If you have DIO•8 cards installed, set the Tape Input and Tape Output format for each card to **ADAT**. OPT•8 cards need no configuration.
2. If the HDR24/96 is the clock master, set the **Sample Clock** to **Internal**. If the HDR24/96 is a clock slave, set the **Sample Clock** to **Word Clock** and depress the 75Ω termination button on the Sync card.
3. Set the **Sample Rate** to 44.1kHz or 48kHz according to your preference.

Console Settings

1. If you have DIO•8 cards installed, set the Tape Input and Tape Output format for each card to **ADAT**. OPT•8 cards need no configuration.
2. If the D8B is the clock master, set the **Sample Rate** to either **44.1kHz** or **48kHz**, and set the **Apogee Clock** to **Internal** (in the Digital I/O Setup window). If it is a clock slave, then set the **Apogee Clock** to **Word Clock**. Set the Sample Rate to match the **Sample Rate** selected on the HDR24/96.

ADAT Optical Hookup with OPT•8

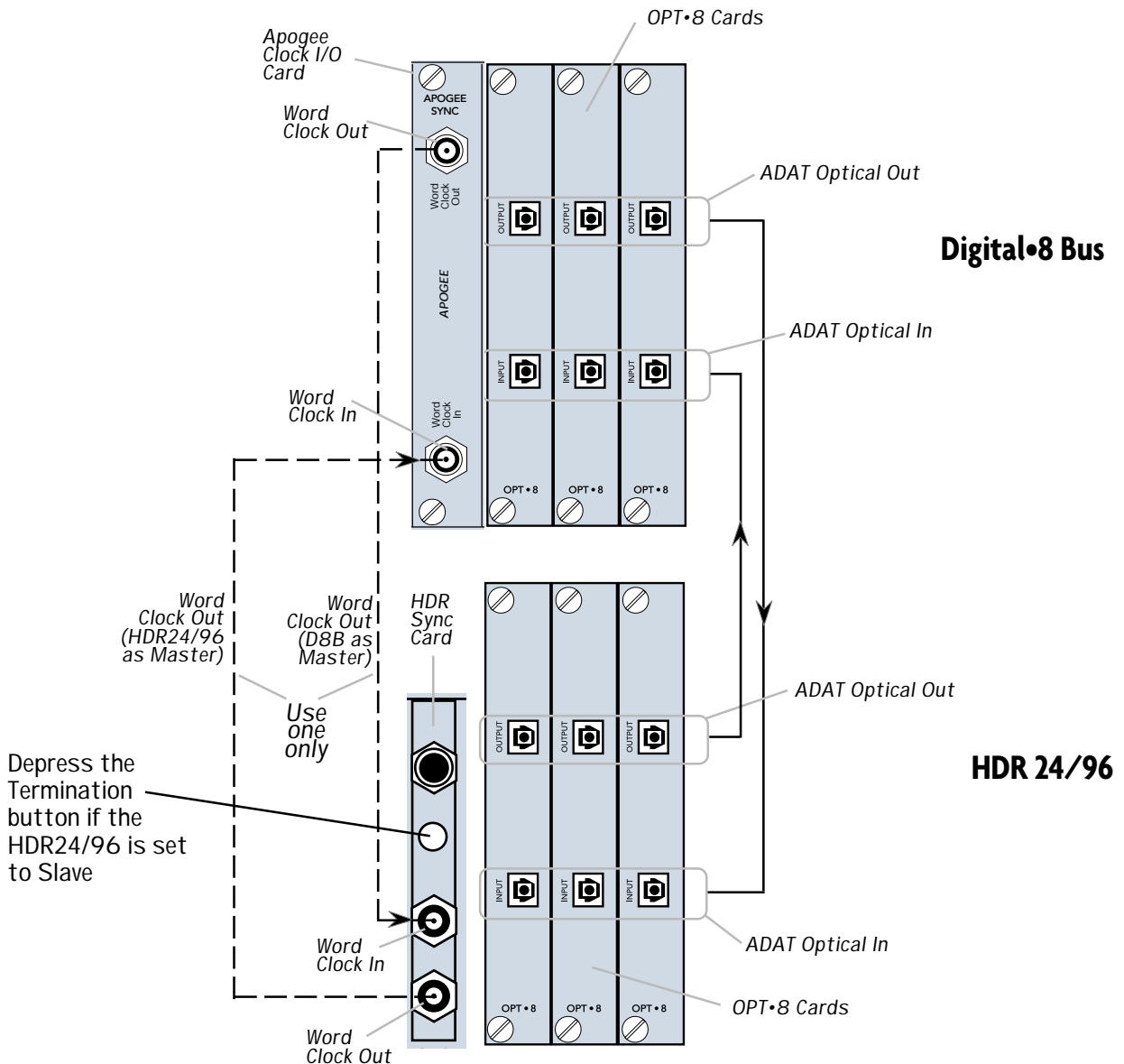

AES/EBU Hookup to HDR24/96 (PDI•8)

Cables & Hardware

- (3) PDI•8 cards for HDR24/96
- (3) PDI•8 cards for D8B
- (1) Clock I/O card for D8B
- (3) DB25 to DB25 AES/EBU snakes
- (1) 75Ω BNC word clock cable

Hookup

1. Connect the three AES/EBU cables between the corresponding AES/EBU connectors on the HDR24/96 and D8B.
2. When AES/EBU is used, the D8B must have a Clock I/O card installed. To make the D8B the clock master, connect its Word Clock Out to the HDR24/96 Word Clock In. To make the HDR24/96 the master, connect its Word Clock Out to the D8B Word Clock In.

HDR24/96 Settings

1. If the HDR24/96 is the clock master, set the **Sample Clock** to **Internal**; if it is a clock slave, set the **Sample Clock** to **Word Clock** and depress the 75Ω termination switch on the Sync card.
2. Set the **Sample Rate** to 44.1kHz or 48kHz according to your preference.

Console Settings

1. If the D8B is the clock master, set the **Sample Rate** to either **44.1kHz** or **48kHz**, and set the **Apogee Clock** to **Internal** (in the Digital I/O Setup window). If it is a clock slave, then set the **Apogee Clock** to **Word Clock**. Set the **Sample Rate** to match the **Sample Rate** selected on the HDR24/96.

AES/EBU Hookup with PDI•8

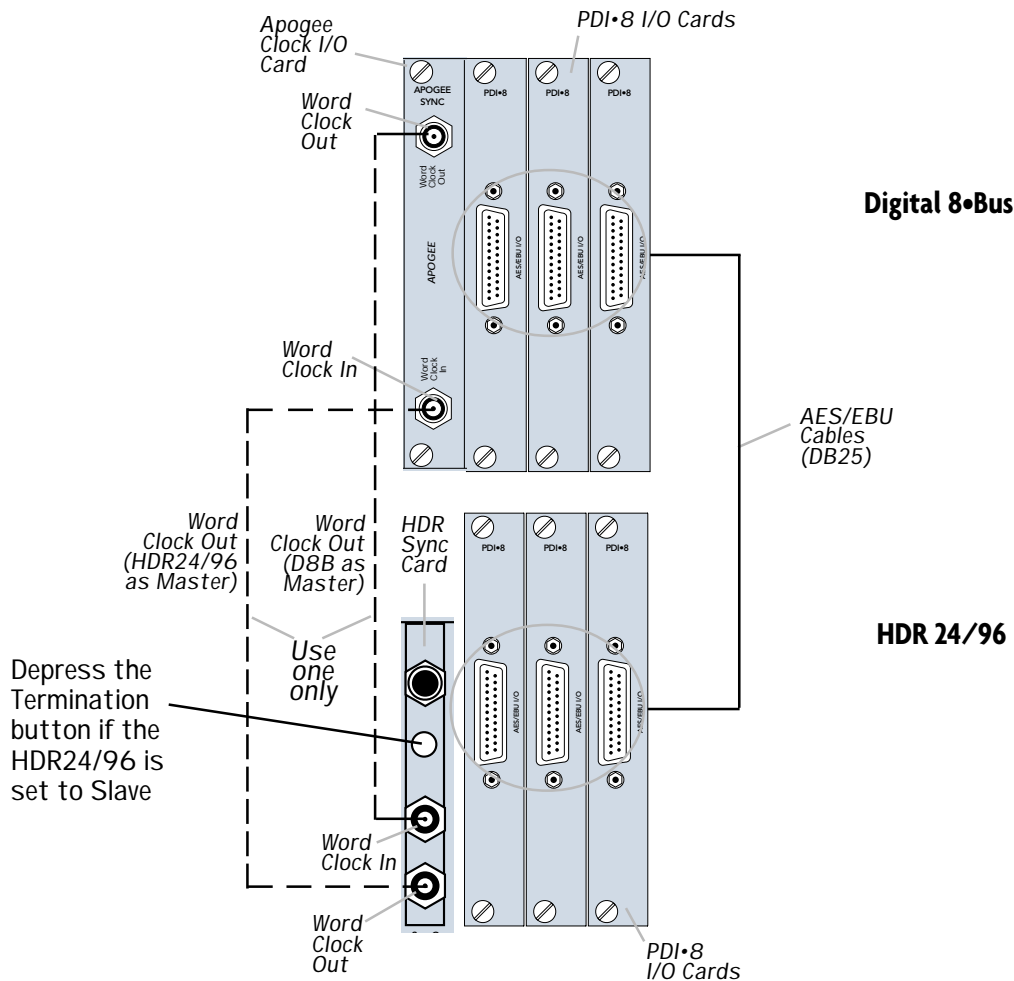



OK, so we fibbed a little. You can use PDI•8 cards in the D8B without a Clock I/O card installed, but doing so requires that you enable sample rate conversion on both the D8B and the HDR24/96 in lieu of word clock synchronization. Sample rate conversion results in a 4-bit loss in sample resolution that may degrade the quality of the sound slightly. On the positive side, you don't need a Clock I/O card!

Using the Digital 8•Bus with ADATs

This is a simple setup. It works well and is easy to configure. However, it has some limitations. Without a MTC sync source there's no way for the Digital 8•Bus to time-reference snapshot or dynamic automation. As long as automation isn't a consideration, this setup is clean and efficient.

Cabling and Hookup

1. Connect a fiber optic cable between the ADAT's lightpipe output and the D8B's lightpipe input. Likewise, connect the D8B's lightpipe output to the ADAT's lightpipe input. (A DIO•8 or OPT•8 lightpipe card must be installed in the D8B to gain access to the ADAT digital tape inputs and outputs.)
2. When using multiple ADATs, connect SYNC OUT from the master ADAT to SYNC IN of the first slave, then from SYNC OUT of the first slave to SYNC IN of the second slave, and so on.

Settings

D8B

1. Open the Setup window.
2. Click on "Digital I/O" to open the Digital I/O dialog box.
3. Click on each Tape Input and Output box and select ADAT for each DIO•8 card installed.

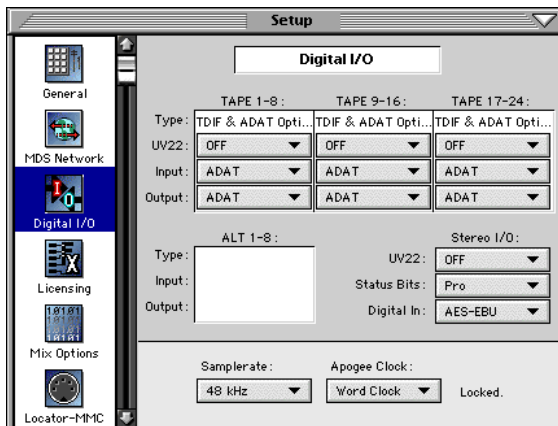

4. Set "Samplerate" to match the sample rate of the formatted ADAT tapes (typically 48kHz or 44.1kHz).

ADATs

1. Select DIGITAL IN on the ADAT front panel.

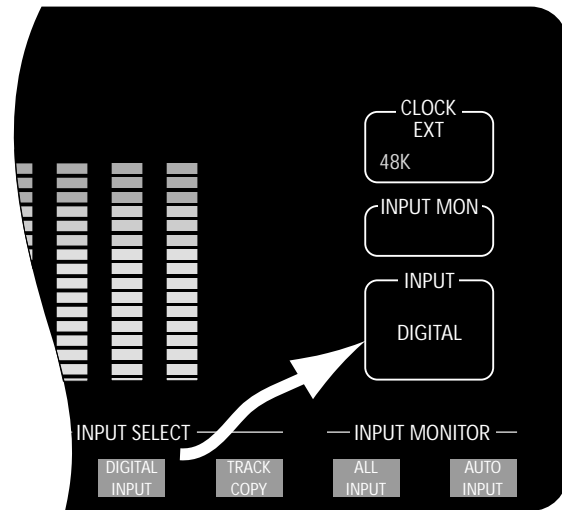
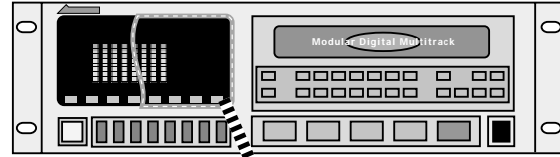

Note: When powering up, turn the Digital 8•Bus on first, then turn the ADATs on.

Connecting the Digital 8•Bus to a BRC and ADATs

The inclusion of a BRC controller or, for that matter, any other sync controller box with word clock and MTC, vastly increases the capabilities of the Digital 8•Bus. With centralized controls, common sync reference, and MIDI Time Code communication established, the digital system works together as one unit. Automation is achieved, referenced to MTC, and digital devices work together, sample-by-sample to make the most of your recordings. (See Figure on next page.)

Cabling and Hookup

1. Connect a fiber optic cable between the ADAT's lightpipe output and the D8B's lightpipe input. Likewise, connect the D8B's lightpipe output to the ADAT's lightpipe input. (A DIO•8 or OPT•8 lightpipe card must be installed in the D8B to gain access to the digital tape inputs and outputs.)
2. Connect a BNC cable from the Clock I/O card's WORD CLOCK OUT connector to the 48kHz IN connector on the BRC.

Note: It is necessary to terminate this connection with a 50 ohm termination at the BRC end of the cable. You will need a BNC "T" connector (Radio Shack part number 278-112; male-female-female configuration) and a 50 ohm BNC terminator (Radio Shack part number 278-270). Connect the "T" connector to the 48kHz IN jack on the BRC. Then connect the BNC cable from the DIO•8 card to one side of the "T" and connect the 50 ohm terminator to the other side of the "T."

3. Connect the 9-pin D-sub sync cables between the BRC (REMOTE OUT TO ADAT) and the first ADAT's SYNC IN connector. Then connect the sync cables in a daisy-chain fashion between the remaining ADATs.
4. Connect MIDI cables between the MIDI OUT connector on the Digital 8•Bus' Remote CPU and the MIDI IN connector on the BRC, and between the MIDI IN connector on the Digital 8•Bus' Remote CPU and the MIDI OUT connector on the BRC.

Settings

Graphics in the previous section will help you locate these controls.

D8B

1. Click the "Setup" button in the bottom menu bar of the SVGA monitor to open the General Setup window.
2. Click the "Digital I/O" icon on the left side of the window to open the Digital I/O dialog box.
3. Click each Tape Input and Output box and select ADAT for each DIO•8 card installed.
4. Set the "Samplerate" to 48kHz.

ADATs

1. On the front panel of the ADAT, select DIGITAL IN.

BRC

1. Set the External Sync parameters to the following:
 - a) Press the EDIT button.
 - b) Set the Clock Source to "48KHz Input."
 - c) Set the Locate Reference to "Internal."
 - d) Press the EDIT button to exit the "Edit External Sync" page.
 - e) Make sure the EXT SYNC button is still lit.
2. Press the EDIT button and the GEN SYNC button twice to bring up the MIDI page. Set the parameter to MTC. Press the EDIT button to exit out of the "Edit Generate Sync" page. Leave the GENERATE SYNC button lit.

Notes:

1. You *must* turn on the Digital 8•Bus first, then turn on the ADATs.
2. Make sure the DIGITAL I/O button on the BRC is *not* lit.
3. Under the MIDI/UTIL button on the BRC, make sure #1 MIDI Echo is off and #8 Output Rew/FF is off. This is so the faders don't run at high speed when shuttling around on your ADATs.

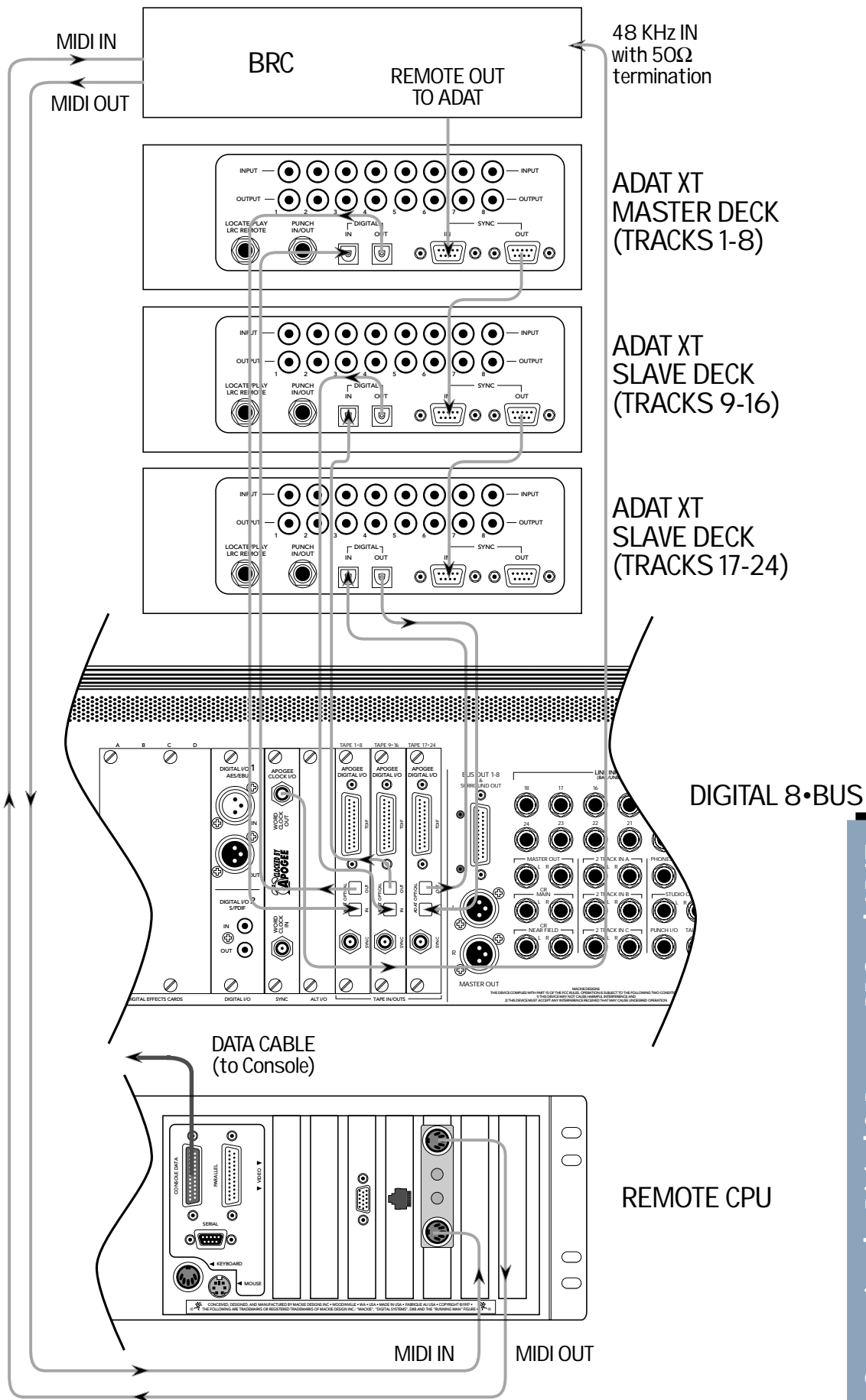

Connecting the Digital 8•Bus to a BRC and ADATs

Connecting the Digital 8•Bus to ADATs Using an External Sync Box

Cabling and Hookup

1. Connect a fiber optic cable between the ADAT's lightpipe output and the D8B's lightpipe input. Likewise, connect the D8B's lightpipe output to the ADAT's lightpipe input. (A DIO•8 or OPT•8 lightpipe card must be installed in the D8B to gain access to the digital tape inputs and outputs.)
2. Connect the 9-pin D-sub sync cables between the Sync Box (SYNC OUT) and the first ADAT's SYNC IN connector. Then connect the sync cables in a daisy-chain fashion between the remaining ADATs. Connect the SYNC OUT on the last ADAT to the SYNC IN on the Sync Box to complete the loop.
3. Connect MIDI cables between the MIDI OUT connector on the Digital 8•Bus' Remote CPU and the MIDI IN connector on the Sync Box, and between the MIDI IN connector on the Digital 8•Bus' Remote CPU and the MIDI OUT connector on the Sync Box.

Settings

D8B

1. Open the Setup window by pressing Ctrl+1 or Setup in the bottom menu bar on-screen.



2. Click "Digital I/O" to open the Digital I/O dialog box.
3. Click each Tape Input and Output box and select ADAT for each DIO•8 card installed.

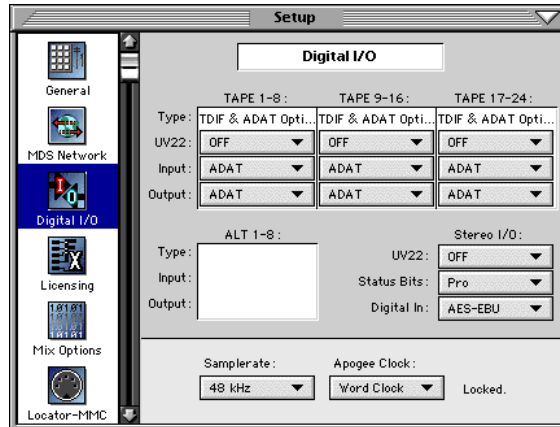

4. Set "Samplerate" to match the sample rate of the formatted ADAT tapes (typically 48kHz or 44.1kHz).

ADATs

1. Select DIGITAL IN on the ADAT front panel.

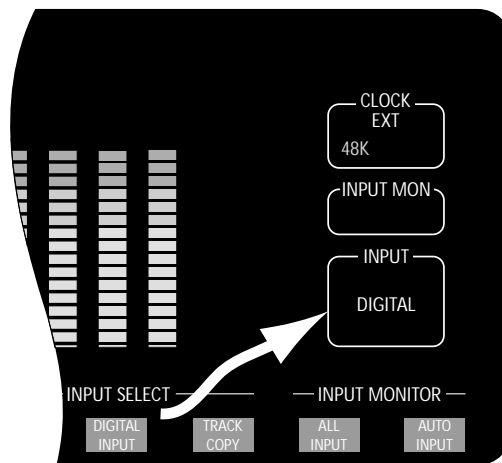
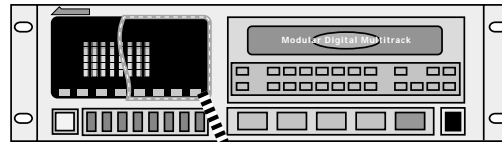

Notes:

- When powering up, turn the Digital 8•Bus on first, then turn the ADATs on.
- Make sure MMC and MTC are lit on the sync box.

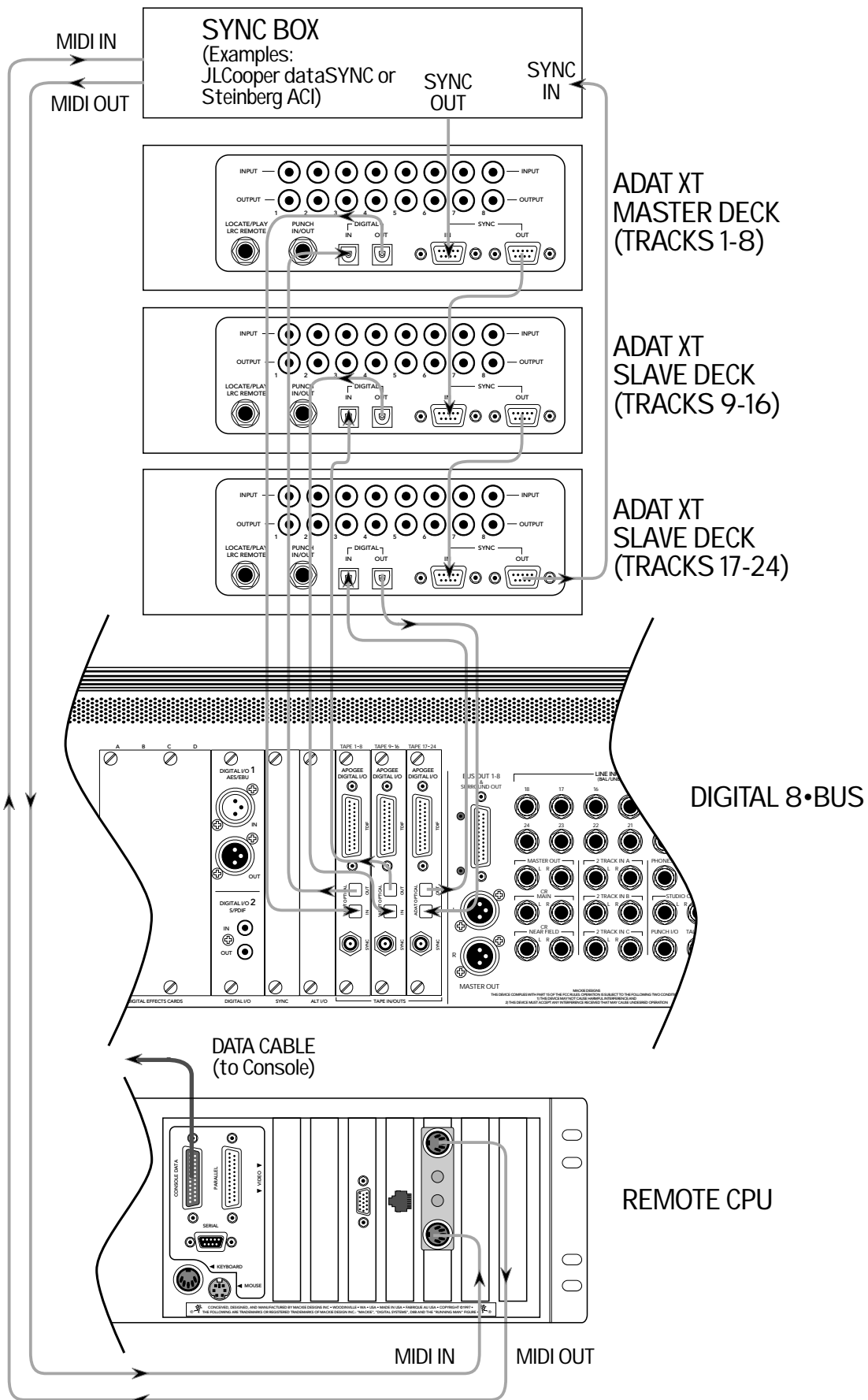

Connecting the D8B to ADATs Using an External Sync Box

Connecting the D8B to TASCAM MDMs

Cabling and Hookup

1. Connect the digital cables between the TASCAM tape decks and the DIO•8 cards in the Digital 8•Bus.

Note: You must use the special dubbing cables provided by TASCAM, part number PW-88D (1 meter) or PW-88DL (5 meters). These cables are reverse wired. Do not use a standard DB25 computer cable, which is wired straight through pin-to-pin.

2. Connect the sync cables (TASCAM part number PW-88S) between the master deck and the slaves in a daisy-chain fashion. Make sure the last deck has a Termination Plug connected to its SYNC OUT connector.

For the DA-38:

An MMC-38 MIDI Machine Control interface must be used prior to the SYNC IN connector on the master deck to implement MMC transport commands and track arming for up to three DA-38 machines.

For the DA-88:

You must have an SY-88 card installed in each DA-88 to implement MMC transport commands and track arming for up to three DA-88 machines. The SY-88 cards also provide SMPTE chase lock operation. Alternately, an MMC-38 MIDI Machine Control interface may be used prior to the SYNC IN connector on the master deck to implement MMC transport commands and track arming for up to three DA-88 machines.

3. Connect a BNC cable from the first DIO•8 (Tape 1–8) card's SYNC connector to the WORD SYNC IN connector on the master deck.
4. Connect MIDI cables between the MIDI OUT connector on the Digital 8•Bus Remote CPU and the MIDI IN connector on the MMC-38 (or SY-88 on the master deck), and between the MIDI IN connector on the Digital 8•Bus Remote CPU and the MIDI OUT connector on the MMC-38 (or SY-88).

Settings

MMC-38

1. Set SW2 DIP switches 6 and 7 to the up position. All other switches should be in the down position.

SY-88

1. DIP switches on the SY-88 are set internally. The DIP switches labeled S2 assign the device ID numbers (see the TASCAM SY-88 Owner's Manual for ID setup information).

TASCAM DA-38/DA-88

1. On the front panel of the TASCAM, select WORD CLOCK as the clock source.
2. Also on the front panel, turn on the DIGITAL IN.

3. Set the Machine ID on each recorder, with the first deck (master) having the lowest number and the last deck having the highest number. DA-88s start with ID #0 and DA-38s start with ID #1.

	DA-88	DA-38
Deck 1	0	1
Deck 2	1	2
Deck 3	2	3

Note: If using a DA-88 as the master and a DA-38 as a slave, assign the DA-88 ID #0, and the DA-38 ID #2.

D8B

1. Click the "Setup" button in the bottom menu bar of the SVGA monitor to open the General Setup window.
2. Click the "Digital I/O" icon on the left side of the window to open the Digital I/O dialog box.
3. Click each Tape Input and Output box and select TDIF for each DIO•8 card installed.
4. Select the appropriate sample rate in the Digital I/O Setup window.

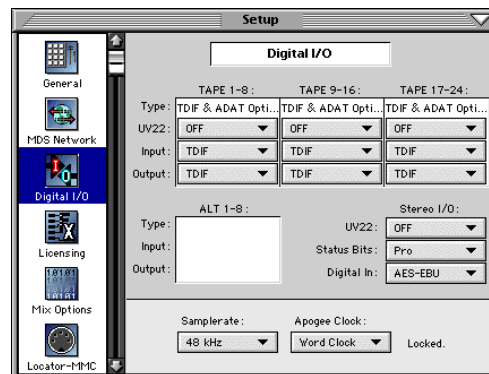

For DA-38s with the MMC-38:

1. Click the "Locator-MC" icon on the left side of the Setup window.
2. Set all Device IDs to 1 (all D8B Device IDs must be set to 1 in order to arm tracks from the console).

For DA-88s with the SY-88s:

1. Click the "Locator-MC" icon on the left side of the Setup window.
2. Set all Device IDs to one digit less than the DIP switch settings (S2) on the SY-88 cards for their respective machines. For example:

	SY-88	D8B
Deck 1	1	0
Deck 2	2	1
Deck 3	3	2



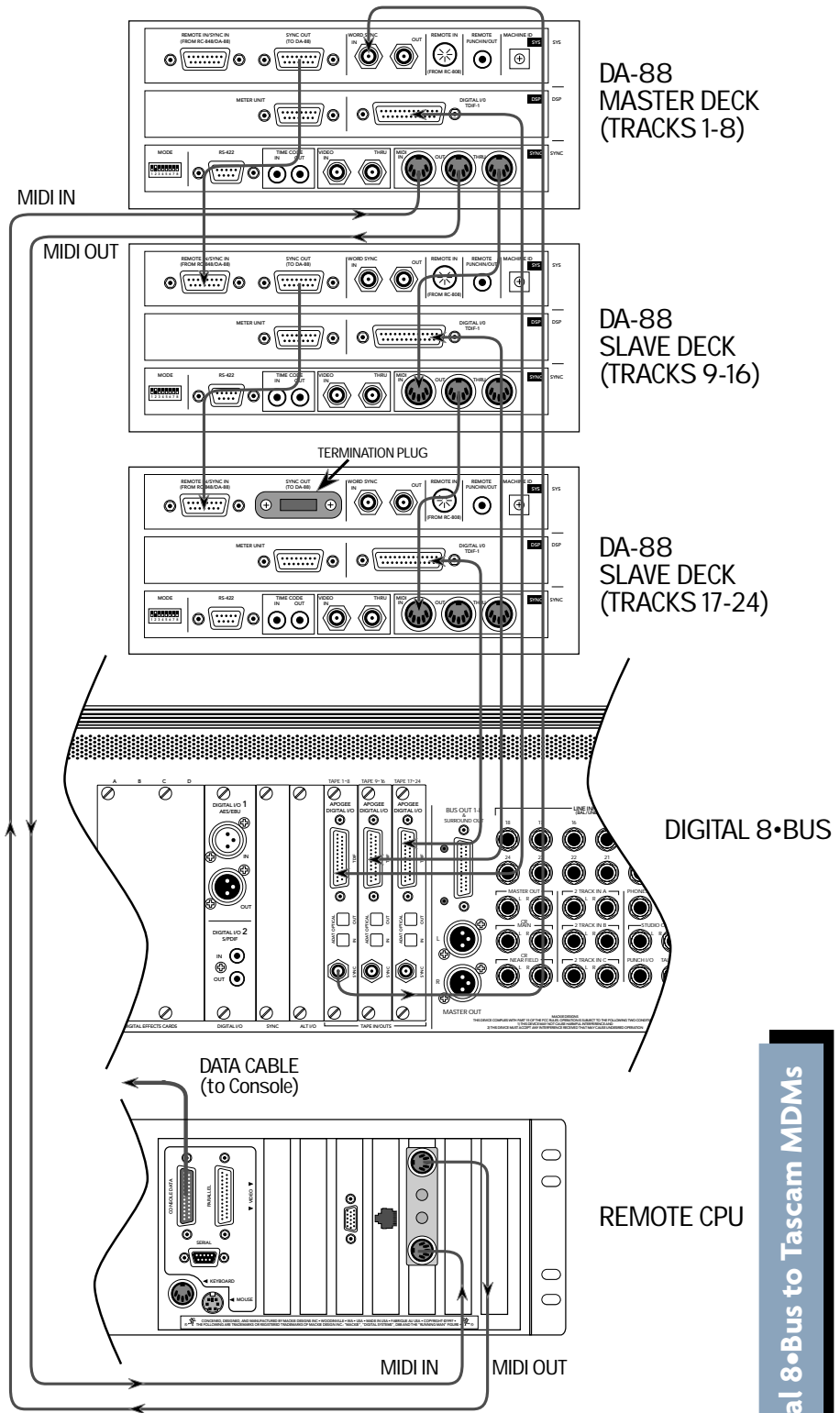

Other Notes

1. You *must* turn on the Digital 8•Bus first, then turn on the Tascam recorders.
2. Make sure the MODE DIP switches on the SY-88 have the 2nd DIP switch in the up position and all the rest of the switches down. This selects the MIDI input.
3. The MMC-38 should have firm-ware version 1.05. The SY-88 should have firmware version 4.01. The DA-88 should have firmware version 4.01.

To determine the firmware version:

MMC-38: Internally marked on EPROM.

DA-88: Hold down the STOP/PLAY/REC buttons while powering up the DA-88 to display the DA-88 ROM version.

SY-88: Hold down the PLAY/REC/FF buttons while powering up the DA-88 to display the SY-88 ROM version.

4. If using any of the newer 24-bit DTRS machines, you should have version 2.1 EPROMs installed in the DIO•8 cards (DIO•8 cards shipped after 7/2000 have version 2.1 EPROMs installed). If the label on the socketed IC (located on the bottom left corner of the DIO•8 card, near the edge connector) has anything but “v2.1” printed on it, you should get the free upgrade by contacting our parts department at 800-258-6883.

Digital Audio Workstation Setup

Connecting the Digital 8•Bus to a Digital Audio Workstation (Digital Performer, Studio Vision Pro, Cakewalk Pro, etc.) shares considerations with the ADAT and TASCAM hookups. Word clock synchronization must be addressed; the master and slaves must be established; the clock rate must be consistent throughout; and the audio path into the console must be intelligently configured.

Note: A Pro Tools system works best when referenced to Superclock sync source, or when connected to a PDI•8 card through AES/EBU with SRC engaged.

Let's consider a common computer-based setup utilizing:

- A combination digital audio/MIDI software package
- A MIDI interface
- A digital audio interface with lightpipe audio connections

Cabling and Hookup

1. Connect the Digital 8•Bus lightpipe output, from the DIO•8 or OPT•8 card, to the digital audio interface lightpipe input. Likewise, connect the lightpipe output from the digital audio interface to the D8Bs lightpipe input.
2. Connect the digital audio interface to the computer per the manufacturer's specifications.

Settings

D8B

1. Open the Setup window.
2. Click "Digital I/O" to open the Digital I/O dialog box.
3. Click each Tape Input and Output box and select the appropriate setting for each card installed.

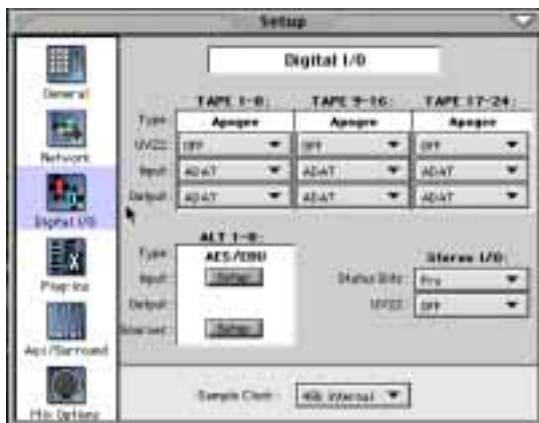

4. Set the Digital 8•Bus "Samplerate" to match the

computer's sample rate (typically 48kHz or 44.1kHz). Selecting "Internal" in the Apogee Clock pull-down establishes the D8B as the master. Everything else in the digital chain must be capable of slaving to the Digital 8•Bus.

DAW

1. Set the digital audio interface to follow ADAT optical at the interface input (from the D8B lightpipe output).
2. Connect the DAW's MIDI/digital audio interface to the Digital 8•Bus inputs and outputs.



Note: Be sure to turn on the D8B before any of the other digital components. In addition, if your setup uses TDIF connections, refer to the previous setup scenario for TASCAM-specific settings.

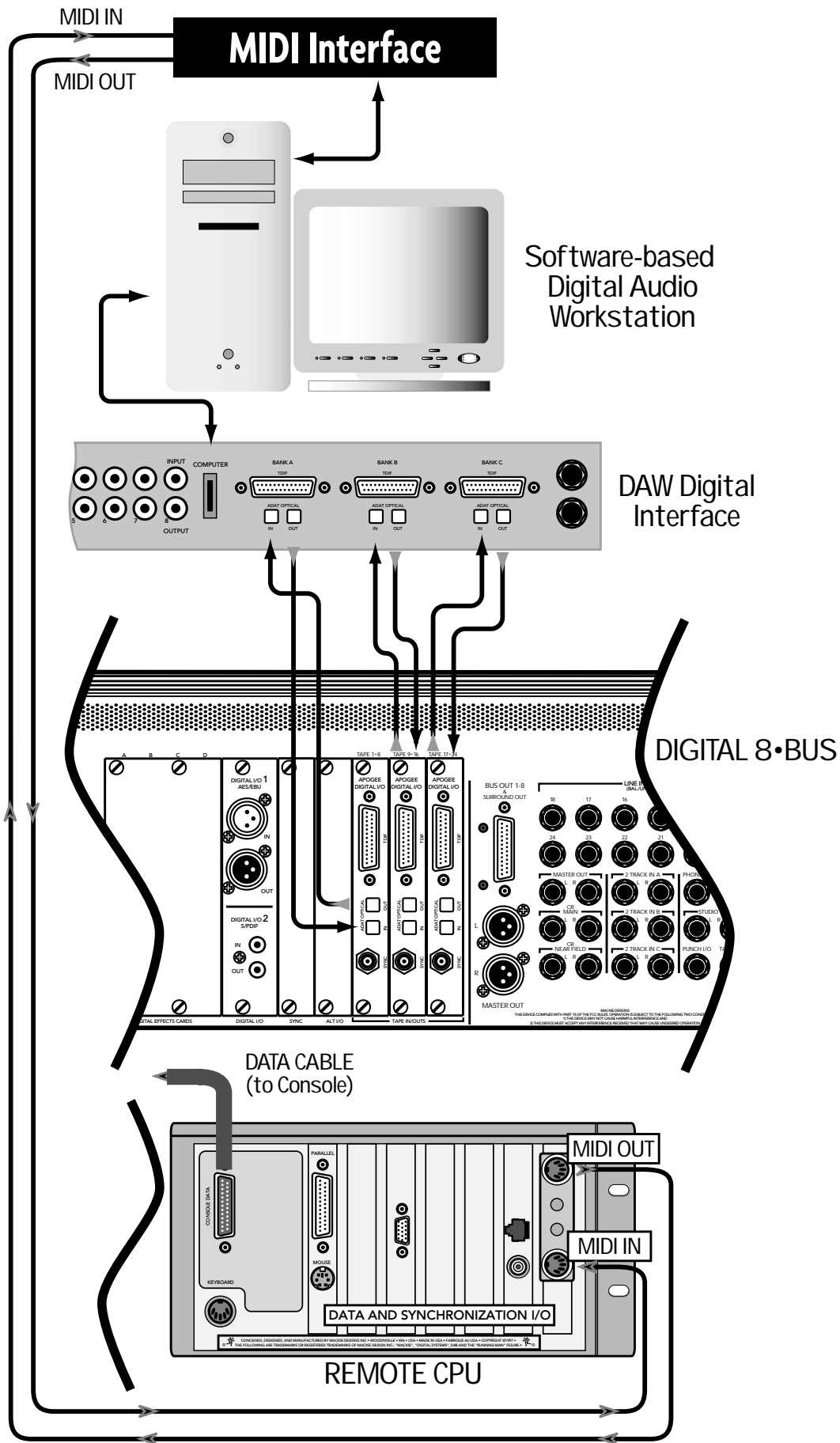

Connecting the Digital 8•Bus to a Digital Audio Workstation

Live Sound/Live Recording Setup

In a live sound/recording application the console fader banks are chained together to form one large console. With the addition of up to 24 more mic preamplifiers, the tape inputs can be used to receive signal from any mic-level or line-level source.

The setups for live concert recording and live sound are similar. Each involves mixing everything as you go—moving faders, or setting and selecting snapshots. Whereas the live concert mix sends the final audio to the monitors and house sound system, the live recording mix sends the final audio to the 2-track recorder and the headphones.

Follow this simple procedure to set up for a live session.

- Power amps off**
- Console power on**
- Select a starting snapshot**
- Turn Master Fader down**
- Connect all mics and instruments**
- Setup sample clock**
- Power amps on**
- Select Mic/Line fader bank**
- Press Mic button on channels using microphone inputs**
- Set Pre-Fader auxes in Setup Window for monitor use**
- Test each instrument and mic to verify level at console input meter**
- Adjust input trim for a reading around 15 on the meter**
- Press L/R in the ASSIGNMENT section to confirm Assign lights on for all desired channels. Or, look on-screen to verify all channels have L/R button highlighted in Bus Assign section**

Live Application Tip #1: Buses 1–8 don't sum to L/R Mix internally. Therefore, to utilize buses as masters, route the bus (sub) out the Alt I/O then back into any channel or Alt I/O input. Or, simply use the virtual groups as level and mute masters.

- Set Master Fader to Unity position**
- Turn channel faders up to hear instrument or mic.**
- Once the appropriate level is achieved, press the channel mute button.**

- Set up a quick mix using level, pan, EQ, dynamics, effects**
 - Adjust mix to the cue (headphone) buses.**
 - Store and label snapshot(s)**
-

Live Application Tip #2: Don't forget the Snapshot filters. If you find a parameter setting that you want to keep throughout the performance (EQ, plugin, compressor, etc.), simply filter that parameter out of your saved set of snapshots. All your changes will still happen on cue as you scroll through snapshots, but your updated parameters will remain constant.

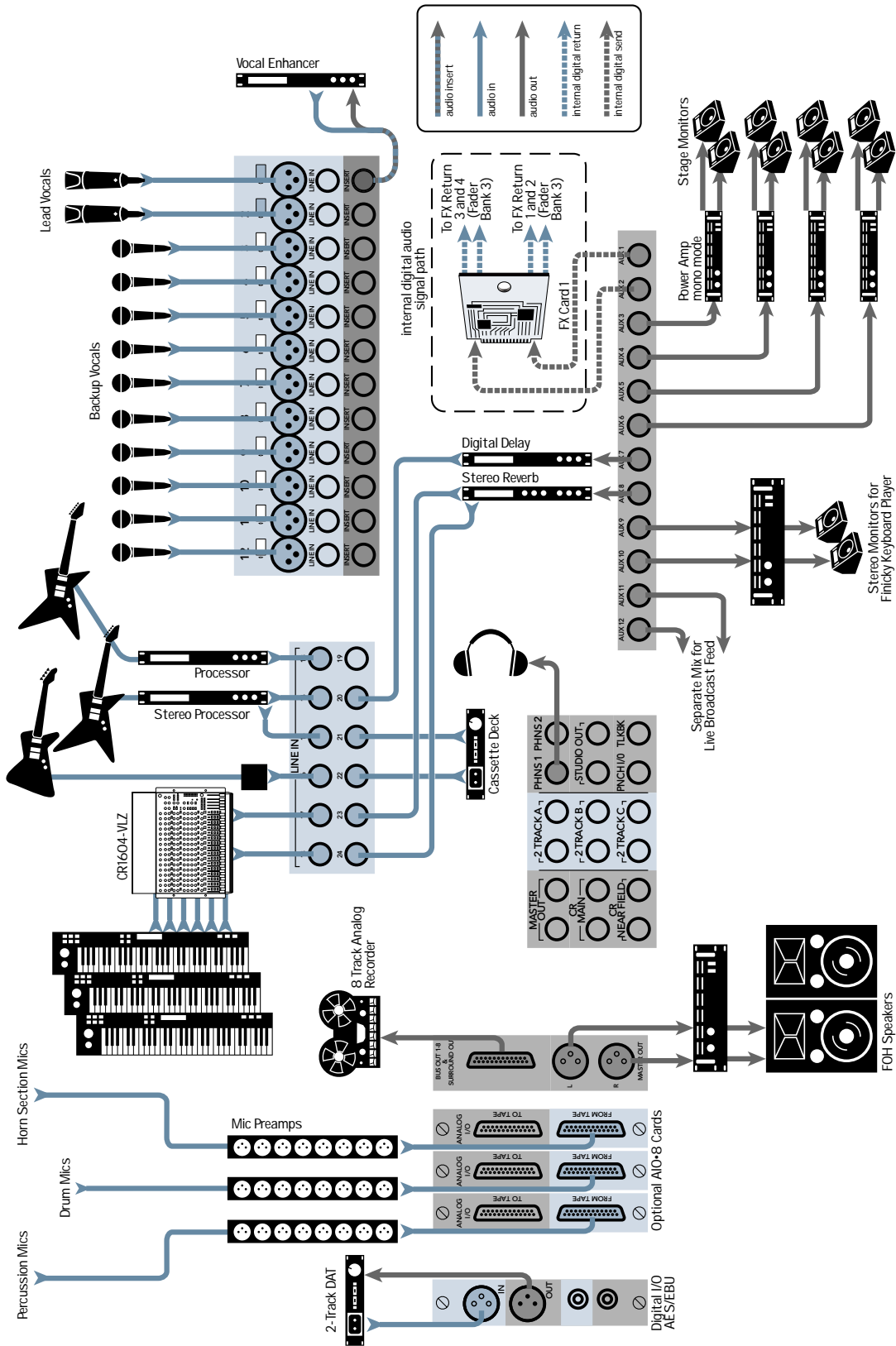

Connecting the Digital 8-Bus for Live Sound/Live Recording

Post-Production Setup

The Digital 8•Bus is an amazing tool, no matter what the setup. However, the more complex the setup, the more amazing the D8B becomes. Post-production provides potential for any tracks, effects, snapshots, automation moves, and general madness mayhem.

Most post-production facilities use house sync to lock all video equipment together. The same piece of gear that generates house sync can provide the D8B and all connected audio gear with the necessary word clock to get everything functioning properly together.

In order for the D8B to follow external word clock, an Apogee Clock I/O card is required. With the Clock I/O card installed, the available sample clock options increase. The D8B will slave to most any clock source from 32kHz to 48kHz.

This is also the type of setup that might be found in a home studio that incorporates a central sync generator.

Bouncing/Summing Using Bus Outs

You may find that you need to free up some more tracks to get everything to fit. You can do a submix and combine several tracks into one (or two) using the BUS 1–8 Submasters.

Maybe you have six separate tracks for the kick drum, snare drum, cymbals left, cymbals right, tom 1, and tom 2. You can free up five extra tracks by bouncing these down to one track, or free up four extra tracks if you want to bounce them down to a stereo pair of tracks.

The following steps show an example of how to bounce tracks 1–6 down to tracks 7 and 8 by using Bus 1 and 2. By using Buses 1 and 2, whatever pan positioning you've set up is retained.

1. Select Fader Bank 2 by clicking the TAPE button next to the Master Fader.



2. Turn off the L-R assignments for channels 25–30 (tracks 1–6 returns). Turn off the L-R assignments for any other channels you don't want to monitor while bouncing down.

3. Click and hold on the “1” button at the top of channel 1. Sweep across to channel 6 to assign channels 1–6 to Bus 1.
4. Click and hold on the “2” button at the top of channel 6. Sweep across to channel 1 to assign channels 1–6 to Bus 2.



5. Click the MASTERS button next to the Master Fader to select Fader Bank 4.
6. Click and hold on the OUT box at the top of BUS 1 (channel 89). Drag down to “Tape Out 7” to assign Bus 1 to the multitrack record device track number 7.

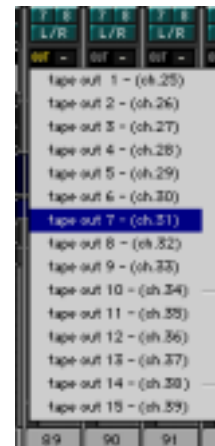

7. Click and hold on the OUT box at the top of BUS 2 (channel 90). Drag down to “Tape Out 8” to assign Bus 2 to the multitrack record device track number 8.
8. On the recording device, select record ready on the tracks 7 and 8.
9. Play the song while recording tracks onto the multitrack.
10. With the original 6 channels muted, monitor the bounced track on the D8B TAPE IN bank (channels 31 and 32).

Using Basic Automation

What Type of Data Can Be Automated

Virtually all of the D8B channel parameters are available for automation. However, there are a few exceptions—some obvious and some not so obvious. All D8B channel parameters can be automated except:

- Analog Trims on channels 1–12
- Tape Output selection
- Pre and Post insert selections
- Plug-in Configuration selections—even though plug-in parameters can be automated
- Channel reconfigurations

Two Types of Automation

Automation moves are divided into two basic types: **snapshot and dynamic**. Snapshot automation makes it possible to instantly reset all automated console settings to a predetermined fixed (static) position with a single command (snapshot recall). Dynamic automation allows you to record and play back any parameter changes, like fader positions or mute toggles, in real time while locked into time code.

The Digital 8•Bus is powered by Mackie's Real Time OS™ automation software. Upon initial power-up, the console Automation Section is bypassed.

Snapshot Automation

As described in Chapters 2 and 3 of this manual, snapshots are simple and painless to store on the D8B.

Snapshot automation refers to simply scrolling through various snapshots at the appropriate time and place. (Recalling snapshots in the proper order and position can be accomplished through connection to a MIDI sequencer, or by placing snapshot events in the Event Automation Track.)

Your MIDI sequencer sees a snapshot selection as a simple patch change, which can be recorded as part of the same sequence that might contain all or a portion of your music.

- Set the sequencer to receive and record MIDI patch change data from the D8B MIDI channel and cable.
- Select "MIDI Snapshots" in the Setup>Mix Options window.
- Run the sequence with the D8B receiving MTC from the sequencer.
- Place the sequencer in record mode on the D8B channel as you scroll through snapshots. Each of these snapshot changes record into the sequence.
- Play the sequence back with the D8B receiving MIDI playback at its MIDI input.
- Snapshots will playback in the same time and order that you selected them.

- To fine-tune snapshot placement, open the sequence track and adjust the time position in the MIDI sequence.

Dynamic Automation

Dynamic automation is a function of the D8B automation system. The power and flexibility offered by the D8B is awesome. This one tool can revolutionize the way you do music.

Each new automation pass helps mold and shape the music into a brilliant work of art. Dynamic automation involves real-time crafting of the mix with the assistance of a computer processor.

Where Do I Start?

Automation is somewhat intimidating at first. Fortunately, it doesn't need to be. The power, flexibility, and ease of use provided by the Mackie designers makes the D8B painless and intuitive.

If you've used other automation systems, you have a definite advantage. The concepts involved, as they apply to the D8B, are similar to most automation systems. The advantage the D8B offers over most other automation systems is its mind-boggling ability to automate virtually every parameter on the console.

The following is a step-by-step, streamlined procedure to help get you automating. To clarify terminology and basic layout, refer to Chapter 2 of this manual.

Automation In Bypass

- Begin by setting up a basic mix with automation off. Select BYPASS in the Automation section of the control surface in the Options/Automation window, or in the on-screen Locator window.

Clear Automation

- To avoid errant data, select all channels and clear all types of automation data.
- Select Mic/Line bank, then Select All (Control+A).
- Select Fader bank, then Select All (Control+A).
- Select Effects bank, then Select All (Control+A).
- Select Masters bank, then Select All (Control+A).
- Choose Clear Automation... from the Edit Menu. Check all types of data, then OK.

Save Session As...

- Name your Mixes in a manner that is easy to reference consecutive revisions: For example, "BigBadBob Mix 1," or "BigBadBob rev 1.0."
- Using "rev 1.x," "rev 2.x," etc. provides an easy way to indicate major conceptual changes (1.0, 2.0, 3.0, etc.) from minor refinements (1.0, 1.1, 1.2, etc.)

Setup Rough Mix

- Build the basic sound of the mix. Include fundamental EQ, Pan, Surround, Dynamics, Groups, etc.
- Save frequently, or set the D8B for SMART SAVES at regular intervals.

Save Snapshot For Safety

As you build the mix, save snapshots as soon as the music begins to reveal itself. Label the snapshots for your own reference. Sometimes these basic mixes, which are derived from your initial “gut” reaction to the music, are the most powerful.

Basic dynamic automation does not require these snapshot saves, but they’re often useful as the mix comes together, even if only as a cross-reference. If you develop a string of snapshots that are very powerful, they can be strung together during automation. However, the procedure we’re outlining here highlights dynamic automation.

Time Code From Playback Device

Route MTC

The D8B requires MIDI Time Code (MTC) at the MIDI input to operate automation along with the record/playback device.

- Connect the MIDI output of your computer, sequencers, MIDI interface, or transport control to the MIDI input of the D8B.
- Most sequencers or other record/playback devices that transmit MTC need to be configured to route to a specific MIDI channel, cable, or device. Consult your MTC source operator’s manual to confirm accurate and verifiable routing to the D8B.

Verify MTC at D8B Transport SMPTE Window

- When your sequencer or other record/playback device is running and MTC is transmitted, the D8B control surface position readout window will scroll MTC. You will see a continuous increase of Hours, Minutes, Seconds, and Frames. If you see this scrolling time code in the D8B POSITION display, it’s almost automation time!
- MTC also displays in the on-screen Locator window.
- If SMPTE VIEW is not selected, the readout will display Bars/Beats/Ticks (BBT). Press the SMPTE VIEW button at the left of the control surface readout to toggle between SMPTE and BBT.

Set Default Levels...

Once your ducks are in a row, you’re ready to begin the automation process! The Set Default Levels...” command determines the starting point for the entire mix. Fader levels can be written from the beginning of time code (00:00:00:00) to the end (23:59:59:30).

If you don’t set default levels to your preference, levels will jump to any previously selected automation settings as soon as MTC begins. This can be very frustrating, but if you’ve religiously saved snapshots of your mix status, you won’t be far from repair.

- Determine that your mix is solid enough that you’d like to have all parameters written as defaults. Don’t get too freaked out about this—

you’ll be tweaking the mix to perfection anyway.

- Verify that all channels are selected by choosing each of the four fader banks and confirming that all SELECT buttons are highlighted.
- Select Set Default Levels... from the Edit Menu.
- Respond “Yes” to complete the task.
- If you need to recall your static mix at any point, you can save or update snapshots at any time.

Exit Bypass Mode

Once the default levels have been set, it’s time to exit BYPASS mode. From this point on, any parameter change can be written into automation.

Select Parameters

Choose the parameters you’d like to record as automation data on the first pass. This is typically a great time to ride basic fader, mute, and pan settings. However, there is no problem with selecting Faders, Mutes, Pan, and ALL so no matter what moves you make, they can be recorded and recalled by the automation processor.

Any Combination of Faders, Mutes, and Pans on First Pass

- Choose automation parameters by selecting them in the control surface AUTOMATION section, in the on-screen locator window, or the Options/Automation menu.
- The D8B shows no favoritism to any or all parameter writing during automation. You’ll discover the process that works best for you.

Note: Faders, Mutes, and Pan all apply individually to the one parameter they name. ALL applies to all automation parameters other than Faders, Mutes, and Pan.

Safety Net: You can undo any automation record pass or series of record passes using the History List. You can also redo your undo. Or undo your redo. Or undo your hairdo.

Auto Touch Mode

Auto Touch mode offers great flexibility and ease of use. When AUTO TOUCH is selected, automation data is recorded instantaneously for any parameter as soon as you change its setting.

Select AUTO TOUCH by highlighting the control surface AUTO TOUCH button, clicking AUTO TOUCH in the on-screen Locator window, or selecting Auto Touch in the Options/Automation menu.

You’ll know you’ve succeeded in writing automation data when you see the yellow light illuminate the control surface WRITE button or the on-screen channel WRITE icon.

Start playback device

- Verify MTC in the Locator position readout.
- Verify selection of desired automation parameters—for now select FADERS, MUTES, PAN, and ALL.

Move a channel fader

- As soon as the fader moves, the WRITE button illuminates, indicating automation data is being recorded.

Exit Record and Rewind to Beginning of Track

- Stop playback or press the WRITE button on the active channels to exit automation record mode. Rewind playback/Record device to the beginning of the automation pass.

Start Playback from Beginning of Track

- If you've followed these directions thoroughly you'll see the fader move that you recorded playback automatically.
- Welcome to the wonderful world of D8B automation!

Repeat this Action for More Parameters

- Be sure you've selected the desired parameter before attempting the automation pass.
- Each time you perform a new automation pass, new data combines with the old in a seamless manner. Continue building the mix until everything is just right.

Note: Auto Touch mode does not require any channel selection for automation to record! Simply move virtually any parameter on any channel to activate the record status for that channel on that automation parameter.

Write Ready Mode

It's possible to build an entire mix using Auto Touch mode. It is easy to use, easy to build on, and it offers incredible creative flexibility. However, there are instances where Write Ready mode provides the perfect mode for a particular task.

Write Ready Mode is very useful when several channels must be placed into automation record mode at the same time.

Toggle the AUTO TOUCH button off

Activate the Desired Automation Parameters

- Engage FADERS, MUTES, PAN, and/or ALL in the same manner as previously described.

Select Write Ready Mode

- This option is located in the Setup>Mix Options window as "Use Write Ready" and in the Options/Automation Menu as "Write Ready Mode."
- In this mode, the Transport RECORD button is necessary for completing an automation pass.

Press WRITE on All Desired Automation Channels

- The yellow light or icon blinks, indicating record-ready status.

Start the Playback Device

- Even when the playback device starts, the automation system remains in ready status (yellow lights blinking) until the RECORD button is pressed in the control surface Transport section or the on-screen Locator window.

Press the D8B Record Button

- Press the RECORD button on the control surface in the transport control section or in the on-screen Locator window.
- Once record status has been achieved, the blinking yellow lights remain solid until the transport stops or the WRITE button is pressed.
- For the write-ready channels, fader, mute, and pan automation data is written as soon as record is pressed.
- For all other parameters (other than fader, mute, and pan), even though RECORD is pressed, automation data isn't actually recorded until a parameter change is made.

Note: Operation characteristics of the Transport RECORD button are determined by the settings in the Setup>Mix Options window. Select "One Button Punch" to enable record status by simply pressing the RECORD button alone. If "One Button Punch" is not selected the user must hold PLAY while pressing RECORD to enter record mode. Press Play or Stop to punch out of record.

Exit Record and Rewind to Beginning of Track

Start Playback from Beginning of Track

Repeat this Action for More Parameters

Write Punch-in Mode

This mode functions in a very similar fashion to Write Ready mode. However, in this mode the Transport RECORD button is not needed.

Exit AUTO TOUCH Mode

Deselect Write Ready Mode

- This option is available in the Setup>Mix Options Menu and in the Setup>Mix Options window

Start Playback Device, then Press the Write

Button(s) on the Desired Channels

- In this mode, pressing the channel WRITE buttons immediately places the channels into automation record mode.
- Pressing an active WRITE button (yellow light solidly on) immediately punches out of automation record mode for that channel.

Adjust Automation Parameters on the WRITE-

Enabled Channels

- It's always important to verify the correct selection of intended automation parameters.

Exit Record and Rewind to Beginning of Track

Start Playback from Beginning of Track

Repeat this Action for More Parameters

Trim Levels

This mode is perfect for updating sections of a mix. If you've worked and toiled over a track throughout a mix, adjusting the levels frequently, try TRIM mode. This valuable mode simply adds or

subtracts the same amount from a previously adjusted automation track. For example, when used for faders, all moves are maintained but the overall volume changes.

Press TRIM LEVELS

- Press TRIM LEVELS in the control surface Automation section, on-screen Locator window, or in the Options>Automation menu. Notice that the faders all snap to unity position.

Choose Automation Mode

Even though TRIM LEVELS is selected and the faders all move to unity position, the automation modes still retain their operational character.

Use Channel Faders to Boost or Cut Previously

Automated Channel Data

- The faders automatically set at unity so they can be easily used to boost or cut the previously adjusted track content.
- This is an excellent mode to globally adjust channel levels.
- Simply raise or lower the fader level to boost or cut the sum of your previous adjustments for the selected channel.

Auto Touch, Write Punch-in, and Write Ready Modes Function in TRIM mode, also

Automate EQ, Dynamics, and Effects

Automation of EQ, dynamics, and effects is simple.

- Select automation mode (ALL).
- Start the playback/record device.
- Activate automation record command.
- Make changes.

In order for these parameters to record, ALL must be selected in the control surface AUTOMATION section, on-screen Locator window, or in the Options/Automation window.

Automation Procedural Checklists

These checklists are designed as skeletal reminders of the processes previously described. If you follow them and have a basic understanding of the D8B automation system, they'll help instill an efficient automation procedure.

Automation Start-up Procedure

- Automation In Bypass
- Clear Automation
- Save Session As...
- Set Up Rough Mix
- Save Snapshot For Safety
- Route Time Code (MTC) From Playback Device to D8B MIDI Input
- Verify MTC at D8B Transport SMPTE Window
- Set Default Levels...
- Exit Bypass Mode
- Select Parameters
- Any Combination of Faders, Mutes, Pans, and All

Auto Touch Summary Checklist

- Enter Auto Touch Mode
- Start Playback Device
- Move a Channel Fader
- Exit Record and Rewind to Beginning of Track
- Start Playback from Beginning of Track
- Repeat this Action for More Parameters

Write Ready Summary Checklist

- Exit the AUTO TOUCH and/or TRIM LEVELS Mode
- Activate the Desired Automation Parameters
- Select Write Ready mode in Options>Automation
- Press WRITE on All Desired Automation Channels
- Start the Playback Device
- Press the D8B Record Button
- Adjust faders, mutes, or any selected parameters on the WRITE enabled channels
- Exit Record and Rewind to Beginning of Track
- Start Playback from Beginning of Track
- Repeat this Action for more channels and Parameters

Write Punch-in Summary Checklist

- Exit AUTO TOUCH and/or TRIM LEVELS Mode
- Exit Write Ready mode in the Options>Automation Menu
- Start Playback/Record Device and Verify MTC
- Press the Write Button(s) on the Desired Channels
- Adjust Automation Parameters on the WRITE-Enabled Channels
- Exit Record and Rewind to Beginning of Track
- Start Playback from Beginning of Track
- Repeat this Action for More Parameters

Trim Levels Summary Checklist

- Press TRIM LEVELS
- Choose Automation Mode (All Modes Function as Expected)
- Start Playback/Record Device and Verify MTC
- Use Channel Faders to Boost or Cut Previously Automated Channel Data
- Exit Record and Rewind to Beginning of Track
- Start Playback from Beginning of Track
- Repeat this Action for More Parameters
- Exit Trim Levels to Return Faders to Normal Mode