

AC POWER CONSIDERATIONS

Each SP2400 draws an average of 6 amps of AC line current (@ 120VAC) when fully loaded and playing music with a relatively high crest factor.

VOLTAGE CONVERSION

The SP2400 can be configured to operate at 115V AC or 230V AC. See Appendix C for instructions on how to change the operating voltage configuration.

THERMAL CONSIDERATIONS

 **IMPORTANT:** The SP2400 is convection cooled rather than fan cooled. This design was chosen to avoid the requirement for periodic air filter maintenance, and to keep the insides of the SP2400 clean in dirty environments (rather than blowing dirty, smoky air into it). Heat is drawn away from the amplifiers by the heatsinks and radiated through the cooling vents in the top cover. When installing the SP2400, be sure to allow sufficient air space around the top and rear of the amplifier to allow adequate cooling for the heatsinks. If installing in a rack, *leave at least one rack space above and below the SP2400 for a vent, and at least 6 inches behind the chassis to allow proper ventilation.*

If installing three or more SP2400s in a rack, use a fan in the rack to move cool air in and warm air out of the rack's enclosure. It may be necessary to provide a cool air intake fan at the bottom of the rack, and a warm air exhaust fan at the top (see Figure below).

Note: Though it is not required, it is recommended that a warm air exhaust fan be used when two SP2400s are installed in the same rack.

If the amplifier should overheat, a thermal switch is activated that disengages the speaker outputs, allowing the heatsinks to cool down. The **OVERLOAD** indicator on the front panel will also light to show that a protection circuit has been activated. Once the amplifier has cooled to a safe operating temperature, the thermal switch resets and reactivates the speaker outputs. If this should occur, identify the cause of the problem and take corrective action (i.e., provide better ventilation, install a fan in the rack to move more air, make sure the amplifier is not overloaded with too low of a load impedance).

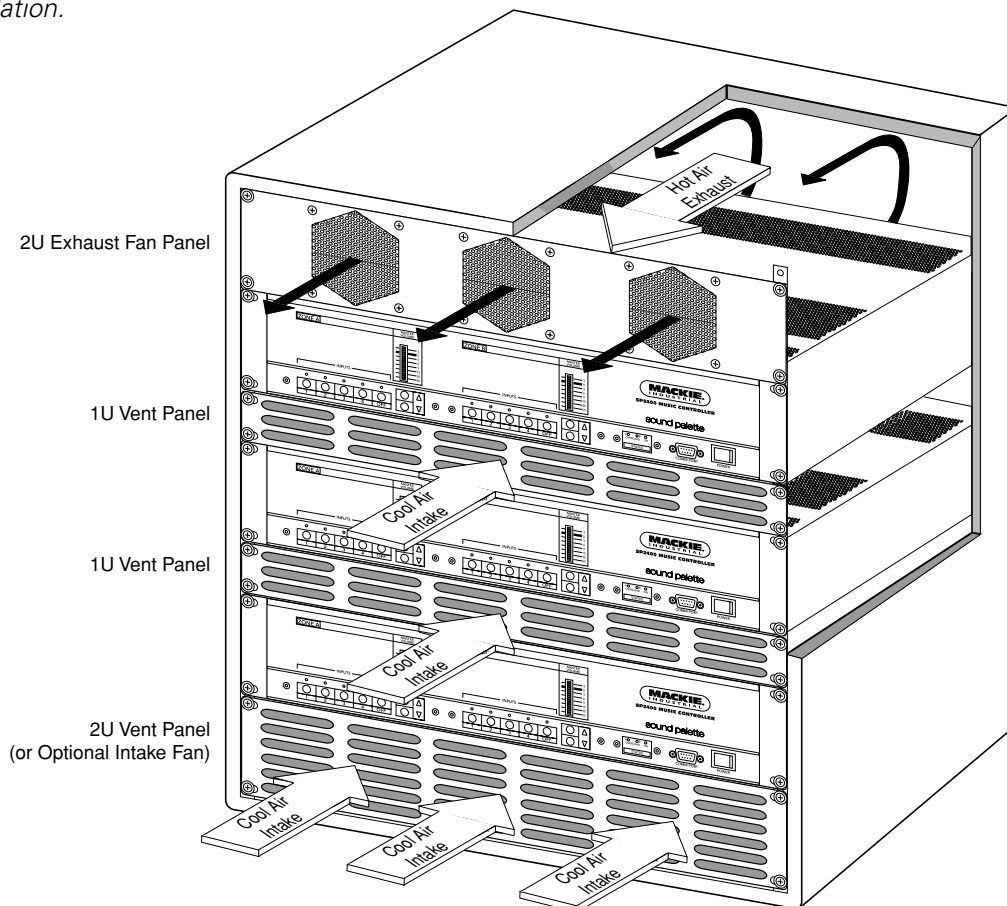

4. OPERATION

SP2400 QUICK START

This isn't a substitute for reading the entire instruction manual, which is the only way to fully understand how the SP2400 works. However, the Quick Start provides a quick overview so you can get the SP2400 set up and working right away.

Make sure the power switch is off while setting up and making connections to the SP2400.

EXTERNAL SWITCH SETTINGS

- The Paging Mic and the Local Mic have +24 VDC PHANTOM power switches. Move the switches down to activate the phantom power if you are using condenser microphones.
- The Paging Mic and Local Mic also have GAIN +40dB switches. Leave the switches in the down position when microphones are connected to these inputs.
- If you plan on connecting two or more SP2400s together in a system with the EXPANSION IN/OUT bus, use the LOCAL/REMOTE switches to select either the local Program Input source (switches up) or a remote program source from the EXPANSION IN/OUT bus (switches down). The odd-numbered switches (1, 3, 5, 7) select the left inputs, and the even-numbered switches (2, 4, 6, 8) select the right inputs.
- If you're using the SP2400 in a stereo configuration, move the STEREO/MONO switches up. If you have a zone configuration planned, leave the STEREO/MONO switches down (default) to combine the left and right channels into a mono signal.
- For stereo operation, assign the same AMP ADDRESS setting to both amplifiers (set the AMP ADDRESS DIP switch #6 to the Master position on one channel and to the Slave position on the other channel). The front panel and remote control panels will operate both amplifiers when they are assigned to the same AMP ADDRESS. For example, if you select Program Input 1 with the Zone A control, Program Input 1 is also selected in Zone B, routing the Program Input 1 left signal to the Zone A (Stereo Left) amplifier, and the Program Input 1 right signal to the Zone B (Stereo Right) amplifier.
- For zone operation, assign different AMP ADDRESS settings to each amplifier. The front panel and remote control panels will operate independently for each amplifier and zone.

INTERNAL SWITCH AND JUMPER SETTINGS

Refer to "Internal Settings" on page 13 for more information.

- Bus Assign switches are used to assign a program input source to the balanced expansion bus. There are four switches for each program input source: Left (+), Left (-), Right (+), and Right (-).



CAUTION : Never assign more than one program source to each of the four expansion bus outputs.

- EQ Bypass allows you to bypass the 3-band EQ, which is in the Input 1-4 signal path. EQ engaged is the default setting.
- The amplifier can be configured for 8-ohm, 70V (default), or 100V operation via eight jumpers on the amplifier board.

PROGRAM INPUTS

Connect any stereo line-level signal source to the Program Inputs 1-4. If you have a music-on-hold requirement, connect a continuous music source to INPUT 1. The DIRECT OUTPUT jacks next to INPUT 1 can feed the signal connected to INPUT 1 to the telephone system.

If you have a need for a priority Program Input (e.g., a jukebox), connect it to INPUT 4. Move the AMP ADDRESS switch #7 UP to enable INPUT 4 priority.

Set the 3-band EQ controls to the "U" position for now (1K for the FREQ control). These can be adjusted later, if necessary.

PAGING MIC INPUT

Connect a microphone to the PAGING MIC input. Use either the XLR connector, or the supplied Phoenix-type connector. Set the PHANTOM and GAIN +40dB switches to their appropriate positions. Adjust the MASTER VOLUME up/down buttons so the meter level is at the "0" mark. Set the GAIN control so the meter indication is near the "0" mark when speaking at an average level into the microphone. See "Setting The Vox Threshold" on page 19 for more information.

Set the 2-band EQ (LOW and HIGH) to the "U" position. This can be adjusted later, if necessary.

PAGING MIC CONTROL

The PAGING MIC CONTROL connector is provided to connect a manual paging switch. Connect a normally-open switch between GND and ZONE A (to page in Zone A only), GND and ZONE B (to page in Zone B only), or GND and ALL CALL (to page over the entire system). The voice-activated (VOX) control for the Paging Mic still operates in both zones when the switch is off.

LOCAL MIC/LINE INPUTS

Connect a microphone to MIC/LINE INPUT A or B (one for each zone), using the supplied Phoenix-type connector, to use for a meeting room or other local speaking requirements. Set the PHANTOM and GAIN +40dB switches to their appropriate positions.

Select the OFF button on the front panel. This disengages the selected Program Source and engages the MIC/LINE INPUT. Adjust the MASTER VOLUME up/down buttons so the meter level is at the "0" mark.

Note: The MASTER VOLUME setting for the MIC/LINE INPUTS is independent of the MASTER VOLUME setting for INPUTS 1-4. The MASTER VOLUME setting for INPUTS 1-4 is stored in memory when the MIC/LINE INPUT is selected (the OFF button is engaged). When an INPUT 1-4 is selected, the MASTER VOLUME setting for the MIC/LINE INPUT is stored in memory.

Set the GAIN control so the meter indication is near the "0" mark when speaking at an average level into the microphone.

Set the 2-band EQ (LOW and HIGH) to the "U" position. These can be adjusted later, if necessary.

AMBIENT MIC INPUTS

This is an optional connection, but can greatly enhance the performance of the Paging Mic. Connect the optional MT-3100 mic to the AMBIENT MIC input (one for each zone). This provides an "ear" for the microprocessor to adjust the Paging Mic gain to compensate for the ambient noise level in the room. Use the supplied Phoenix-type connectors to make these connections.

Note: Move the AMP ADDRESS switch #8 UP to enable the ambient mic. See page 20 for more information on "Using the Ambient Mic."

EXPANSION IN/OUT

If you are connecting two or more SP2400s in a system, use the EXPANSION IN/OUT connections to distribute the Program Input sources assigned to the Expansion Bus between SP2400s. The two 25-pin D-Sub connectors are in parallel (use one to connect to the previous SP2400 and one to connect to the next SP2400 in the chain).

REMOTE

You can connect one or more optional remote controls (up to 10) to each zone on the SP2400 to provide wall-mounted input select, program signal volume control, and local mic volume control.

RS485

A PC can be connected to the RS485 port to provide computer control for up to 16 SP2400s, interconnected via their RS485 ports, using the SPLinker Sound Palette Control software application. If the PC doesn't have an RS485 serial port, you can either install an RS485 interface card, or use an RS232 serial port with an RS232-to-RS485 converter.

Two zones can be controlled with one wired remote control by connecting the RS485 ports between the two zones. (The RS485 ports are connected internally, so an external connection between the RS485 ports on a single SP2400 is not necessary.) Each amplifier must have the same AMP ADDRESS as the amp to which the remote control is connected, with one assigned as Master and the other as Slave. Use the supplied Phoenix-type connectors to make these connections.

Note: Move the AMP ADDRESS switch #6 DOWN for Master and UP for Slave.

PRE OUT/AMP IN

These connections can be used to insert a signal processor (i.e., graphic equalizer, compressor, etc.) into the signal chain, or to feed the signal to additional power amplifiers. If no external processor or external amplifier is to be used, leave the U-shaped jumper in place between the PRE OUT and AMP IN connectors.

OUTPUTS

Use the supplied two-conductor Phoenix-type connectors with appropriate speaker wiring to connect to the speaker or distributed speaker system.

USING INPUTS 1-4

Connect the program sources to Inputs 1-4. These could include a CD player, tape deck, tuner, satellite feed, TV audio, jukebox, or an audio feed from a live band. All four program inputs use unbalanced RCA connectors and accept stereo line-level signals.

Note: The Input Select buttons are labeled 1 through 4 on the front panel. The spaces below the buttons are sized to accept 1/4" labels from the Brother P-Touch Electronic Labeling System. Professional-looking labels can be made to clearly identify the program source connected to each input (visit www.brother.com).

There are no individual volume controls for Inputs 1-4. The SP2400 automatically adjusts the volume for each input using an AGC circuit (Automatic Gain Control). This provides the best signal-to-noise ratio and insures that the volume remains the same when you switch from one source to another.

Only one Input source can be selected at a time. When switching from one source to another, the previous source fades out while the new source fades in (digital crossfade), rather than abruptly switching between the two.

INPUT 1 AND THE DIRECT OUTPUT

Input 1 provides a direct line-level output that can be used for music-on-hold or other external applications. Connect a continuous music source (i.e., satellite feed, prerecorded background music, multi-disc CD player) to Input 1 and connect the **DIRECT OUTPUT** jacks to the external destination.

INPUT 4 PRIORITY

Normally, the four program inputs are non-priority inputs. However, if there is a jukebox or other priority program source in the system, Program Priority can be activated on Input 4 by setting **AMP ADDRESS** switch #7 UP. When a signal appears at Input 4, it overrides the other three inputs. When the signal stops, the SP2400 switches back to the previously selected input source, fading it in smoothly.

STEREO OR MONO

The four program inputs accept stereo signals. The SP2400 can be operated in a stereo configuration or a zone configuration. The **STEREO/MONO** switches should be set to the up position for stereo operation. Set the **AMP ADDRESS** switches to the same address to allow the front panel and remote control panels to operate both amplifiers.

In a zone configuration, move the **STEREO/MONO** switches down to combine the stereo signal into a mono signal for each program source. Set the **AMP ADDRESS** switches to different addresses to allow independent control over each zone.

LOCAL OR REMOTE

These switches are used to select the input source for each of the four Program Inputs. Leave the switches up to select the local input source connected to the **PROGRAM INPUT** connector. Move the switches down to select the remote signal coming from the **EXPANSION IN** connector. Each Program Input has two switches, one for the left input and one for the right input.

BUS ASSIGN

These internal switches are used if you have two or more SP2400s connected together in a system using the **EXPANSION IN/OUT** connectors. Each of the four program inputs can be individually assigned to the **EXPANSION** balanced bus. There are four switches associated with each Program Input source (see the Bus Assign Switch chart on page 13).

Caution: Never assign more than one program source to each of the four expansion bus outputs.

EXPANSION IN/OUT

These two 25-pin D-Sub connectors are used to connect two or more SP2400s together so they can share program sources. This is a true balanced bus and transmits the left and right signal from each of the four inputs over balanced lines. Refer to the "Connections" section on page 12 for information on wiring these connectors.

These connections allow a common program source to be available to all the SP2400s in a system. For example, prerecorded music that is used for music-on-hold can also serve as background music for an entire office building by setting the internal bus assign switches for Input 1 to the up position on the first SP2400. The music is then available to Input 1 on all the SP2400s connected via the **EXPANSION IN/OUT** connectors when their **LOCAL/REMOTE** switches are set to the **REMOTE** position (down).

Note: Switching the **LOCAL/REMOTE** switch to **REMOTE** doesn't disconnect the local input. If a different program source is connected locally to Input 1 on one of the SP2400s in the above example, both the common program source (the remote prerecorded music) and the local program source will be combined on Input 1 and can be played simultaneously. Typically, a local program source would not be connected to an Input which has **REMOTE** selected as the source.

USING THE 3-BAND EQ

This equalizer is applied to the selected program source from Inputs 1-4, whether it is a local source or remote source (via the **EXPANSION IN/OUT** bus).

This equalizer does not affect the paging mic or the local **MIC/LINE INPUTS**, which each have their own 2-band EQ controls.

USING THE PAGING MIC

The paging mic is used to make announcements over the system. If the paging mic is a condenser mic or other type of mic that requires phantom power, move the **PHANTOM** switches to the down position. Otherwise, leave them switched up.

The paging mic can be voice-activated and is routed to both channels or zones. However, you have the option of activating it manually with an external switch. If you choose to use a switch for the paging mic, you have the additional option of assigning the paging mic to either Zone A or Zone B, or to both zones.

- For Zone A only, connect a (normally-open) switch between the **ZONE A** and **GROUND** pins on the **PAGING MIC CONTROL** connector.
- For Zone B only, connect a switch between the **ZONE B** and **GROUND** pins on the **PAGING MIC CONTROL** connector.
- For all zones in a system interconnected via the **EXPANSION** bus, connect a switch between the **ALL CALL** and **GROUND** pins on the **PAGING MIC CONTROL** connector.
- For maximum flexibility, connect three switches to the **PAGING MIC CONTROL** connector and have all three selections available.

The paging mic can be configured to automatically turn down (duck, or attenuate) the music that is playing over the system so the announcement can be heard when using the VOX circuit. When an announcement is over, the music gradually returns to its original volume.

The music ducks fairly rapidly, attenuating the music 20 dB within 300 ms (milliseconds) of detecting a signal on the paging mic. When the signal on the paging mic stops, there is a 1500 ms (1.5 second) timeout period to make sure the announcement is over, and then the music ramps up to its original volume over the next 2.5 seconds.

Note 1: When manually activating the paging mic, there is no timeout period after the announcement ends. The moment you let go of the switch, the music begins to ramp up to its original volume.

Note 2: When the manual switch is off, the voice-activated (VOX) control for the paging mic is still operational. Ensure that the **PAGING MIC VOX** threshold is set accordingly to prevent false triggering of the paging mic input when using **PAGING MIC CONTROL** switching. Alternatively, turn the **PAGING MIC VOX** control all the way up (fully clockwise) to defeat the VOX circuit. Note that each zone has its own **PAGING MIC VOX** control.

SETTING THE GAIN

When a microphone is connected directly to the paging mic input, the **GAIN +40dB** switch should be set in the down position (for a mic-level signal). When the paging mic is going through an external mixer, sending a line-level signal to the paging mic input, move the **GAIN +40dB** switch to the up position (for a line-level signal only).

Adjust the **MASTER VOLUME** control by pressing the up/down buttons so the meter indicates a level at the “0” mark. With all music sources off, speak into the paging mic with a normal voice. Adjust the **PAGING MIC GAIN** control with a non-conductive alignment tool so that the meter indication is near the “0” mark. This provides the best signal-to-noise ratio for the mic, and insures that the signal from the paging mic is strong enough to trigger the VOX circuit.

SETTING THE VOX THRESHOLD

This control determines how strong the signal from the paging mic must be to trigger the VOX circuit, which ducks the program source when an announcement is made. Ideally, the threshold should be set so it is sensitive enough to trigger the VOX circuit as soon as you begin speaking, but not so sensitive as to be triggered by ambient sounds around the microphone. Set the **PAGING MIC VOX** control to the center position with a non-conductive alignment tool to start. Turn the control counter-clockwise to lower the threshold (increase the sensitivity) if the beginning of announcements are getting clipped off. Turn the control clockwise to increase the threshold (decrease the sensitivity) should you experience false triggering due to ambient noise around the microphone.

USING THE EQ

The paging mic has a 2-band equalizer for adjusting the lows or highs on the microphone signal. When the controls are set to “U” (unity), the EQ has no effect on the signal.

USING THE AMBIENT MIC

The ambient mic is an optional accessory (MT-3100) that is available for the SP2400, which is used to sense the ambient noise level in the room. Set the **AMP ADDRESS** switch #8 up to enable the ambient mic, otherwise leave the switch down.

The ambient mic provides an “ear” for the micro-processor to gauge the ambient noise in the room and adjust the gain of the paging mic accordingly. When the background noise is relatively quiet, the paging mic gain is at its lowest level. If the background noise is relatively loud, the paging mic gain is at its highest level. If the background noise is somewhere in between, the paging mic gain is midway between its lowest and highest preset levels.

AMBIENT MIC CALIBRATION AND PLACEMENT

1. Connect the MT-3100 (or other microphone) to the **AMBIENT MIC** connector on the rear panel. Make sure the ambient mic switch is on (**AMP ADDRESS** switch #8 up). Locate the ambient mic in an appropriate position to pick up the ambient noise in the room. It can be mounted on the ceiling or on a wall. Avoid placing the ambient mic close to the speaker over which the announcement is being made. Keep the ambient mic away from a constant noise source, such as a refrigerator or other mechanical device that emits a continuous noise. The best placement is where the mic can pick up an average representation of the ambient noise level in the room.

Note: Each zone or channel must be calibrated individually.

2. Turn off the SP2400, then turn it back on again while pressing and holding the Input 2 button. This causes the ambient mic preamp level to appear on the meter.
3. Establish the highest noise level that you would expect to have in the room using a pink or white noise source, or a music source. Input 1 is operational in this mode to use as a music source, if desired.
4. Adjust the ambient mic preamp gain trim (located just above the ambient mic connector on the rear panel, through the unmarked hole) with a non-conductive alignment tool until all the green LEDs on the meter are lit. Insure that no yellow or red LEDs are lit, which runs the risk of clipping the ambient mic preamp or ADC.
5. Press the “OFF” button when finished to return to normal operation.

PAGING MICROPHONE CALIBRATION PROCEDURE (WHEN USED WITH AMBIENT MIC)

1. Perform the “Ambient Microphone Calibration Procedure” described above.
2. Switch the ambient mic OFF (**AMP ADDRESS** switch #8 down).

3. Adjust the **MASTER VOLUME** control by pressing the Up/Down buttons so the meter indicates a level at the “0” mark.
4. Adjust the **PAGING MIC GAIN** control as high as it will go before feedback occurs while speaking into the paging microphone.
5. Switch the ambient mic on (**AMP ADDRESS** switch #8 up).
6. Turn off the SP2400, then turn it back on again while pressing and holding the “3” button.
7. Release the Input 3 button after a few seconds and the third LED starts flashing slowly.
8. Use the front panel Up/Down buttons to set the lower level of the paging mic (how loud it is with very quiet background noise). It should be loud enough to be heard clearly throughout the coverage area.
9. Press the “OFF” button and the level is stored. The third LED starts flashing faster.
10. Use the front panel Up/Down buttons to set the upper level of the paging mic (how loud it is with very loud background noise). As a general rule, set this level as high as it will go before feedback (at the “0” mark if steps 3-4 above were followed).
11. Press the Input 3 button when finished to store the level and return to normal operation.
12. Verify that the paging microphone’s volume is sufficient to be heard over the background noise in the room.
Note: For best results, with the background noise level at a minimum, the paging mic volume should be approximately the same as the music volume.
13. If the paging microphone is not loud enough to be heard over the background noise, verify that the ambient mic is properly placed to pick up an accurate representation of the background noise. If it is, it may be necessary to readjust the lower and upper levels for the paging mic gain (steps 6-11).

USING THE LOCAL MIC/LINE INPUT

The **MIC/LINE INPUT A** and **B** is provided for each zone to connect a microphone for a speaker in a conference room, or similar sound reinforcement applications. If the local mic is a condenser mic, move the **PHANTOM** switches to the down position.

SETTING THE GAIN

When a microphone is connected directly to the **MIC/LINE INPUT**, the **GAIN +40dB** switch should be set in the down position (for a mic-level signal). When the mic is going through an external mixer, sending a line-level signal to the input, move the **GAIN +40dB** switch to the up position (for a line-level signal only).

Press the **OFF** button to select the **MIC/LINE INPUT**. Adjust the **MASTER VOLUME** control by pressing the up/down buttons so the meter indicates a level at the "0" mark. With all music sources off, speak into the mic with a normal voice. Adjust the **MIC/LINE INPUT GAIN** control with a non-conductive alignment tool so that the meter indication is near the "0" mark. This provides the best signal-to-noise ratio for the mic and insures that its relative volume will be equivalent to the program sources.

USING THE EQ

Each local **MIC/LINE INPUT** has a 2-band equalizer for adjusting the lows or highs on the microphone signal. When the controls are set to "U" (unity), the EQ has no effect on the signal.

USING THE PRE OUT/AMP IN CONNECTIONS

The **PRE OUT** and **AMP IN** connectors are provided to give you more flexibility in your system design. The SP2400 is shipped with U-shaped jumpers installed between the **PRE OUT** and **AMP IN** jacks. This routes the signal from the output of the preamplifier stage to the input of the amplifier stage.

This also provides a point in the signal chain to insert an external signal processor. Simply connect the line-level signal from the **PRE OUT** jack to the input of the processor, and connect the line-level output from the processor to the **AMP IN** jack on the SP2400.

Another option that is available is to connect another amplifier into the system. Simply use a Y-cord at the **PRE OUT** jack to split the signal between the **AMP IN** jack and the input jack on an external amplifier.

LEFT AND RIGHT OUTPUTS

The amplifier outputs on the SP2400 can be used with an 8-ohm impedance load, or to directly drive a 70V or 100V distributed system (also called constant-voltage systems).

DIRECT SPEAKER CONNECTION

If the SP2400 is not being used in a distributed speaker system, you can reconfigure the amplifiers to drive an 8-ohm load. Each amplifier can provide up to 250 watts into an 8-ohm load. See the "Internal Settings" section on page 14 for instructions on how to reconfigure the amplifiers.

DISTRIBUTED SPEAKER SYSTEM

When using the SP2400 in a 70V or 100V system, connect the speaker outputs directly to the distributed system. The SP2400 can directly drive a distributed system's speaker line without the need for an output transformer. The SP2400 can supply up to 200 watts into a 70V or 100V distributed system. Make sure the taps on the speakers in the system do not exceed a total of 200 watts.

USING THE REMOTE CONNECTION

The optional SP2400 Remote Control (SP-41R) provides Input Selection and Master Volume control for each amplifier or zone. The Remote Control can be mounted in a standard double-gang electrical box and covered with a Decora®-style faceplate.

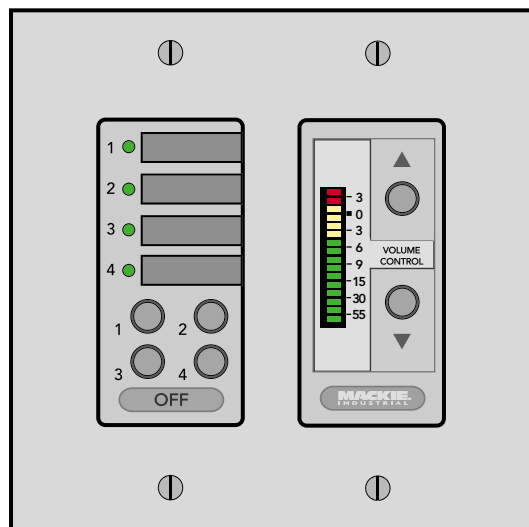

CONNECTING ONE OR MORE REMOTE CONTROLS

Each Remote Control affects only the zone to which it is connected. Up to ten remote controls may be connected to each zone simultaneously. This allows controls to be conveniently placed. Each control will interact with the SP2400, and all controls will reflect the current source and level settings. Note that the remote control indicates the gain setting and not the actual signal level in real time. In addition, the SP2400 provides a method for controlling two independent zones using a single Remote Control by assigning them to the same **AMP ADDRESS** (see next section).

The maximum distance between the remotes and the SP2400 varies, depending on the type of cable selected and the number of remote controls used. Typically, a lower wire gauge and cable capacitance allow longer distances. See the instructions with the remote control for more information.

USING THE RS485 CONNECTION

Each amplifier is equipped with an **RS485** connection. These connectors are linked internally, so if both amplifiers have the same **AMP ADDRESS** assignment, the Input Selection and **MASTER VOLUME** buttons track each other, since they are assigned to the same zone. One side must have **AMP ADDRESS** switch #6 in the Master position (up), and the other side in the Slave position (down).

The same thing can be accomplished between two SP2400s by connecting the amplifiers together with the **RS485** connection. Again, be sure that both amplifiers are assigned to the same zone (**AMP ADDRESS** switches 1-5), one is configured as Master and the other Slave, and that no other amplifiers are connected via the **RS485** port with the same **AMP ADDRESS**.

In this way, you can have one Remote control operate both amplifiers that are assigned to the same zone.

Note: The microprocessor polls the **AMP ADDRESS** switch when it initializes at power-up. If a change is made to the **AMP ADDRESS** switch, turn the SP2400 off for five seconds, then turn it back on again for the new settings to take effect.

USING THE SPLINKER SOUND PALETTE CONTROLLER

The RS485 connection can also be used to connect the SP2400 to a computer loaded with the SPLinker software application. The PC-compatible computer must have an RS485 port to properly connect to the SP2400. It may be necessary to install an RS485 interface card, or use an RS232 port with an RS232-to-RS485 converter.

The SPLinker is a PC-based graphical interface to provide real-time monitoring and control for up to 32 zones. It provides individual program source selection and volume control for each zone. Select boxes are located at the bottom of each zone for selecting multiple zones. All selected zones can then be modified at the same time in the Multiple settings box located on the right-hand side of the screen.

USING A 3RD PARTY CONTROL SYSTEM

The **RS485** connection can also be used to interface with common third-party control systems. Contact the third-party provider or Mackie Industrial Technical Support to determine if your control system is compatible with the SP2400.

UPGRADING THE SOFTWARE

From time to time, Mackie Industrial will release upgrades for the internal operating software in the SP2400. This can be downloaded from our website (www.mackieindustrial.com) to a PC-compatible computer. Use the serial port on the computer to connect to internal connectors on the SP2400's CPU boards to transfer the data to the on-board flash memory. Instructions will be provided when upgrades are available.

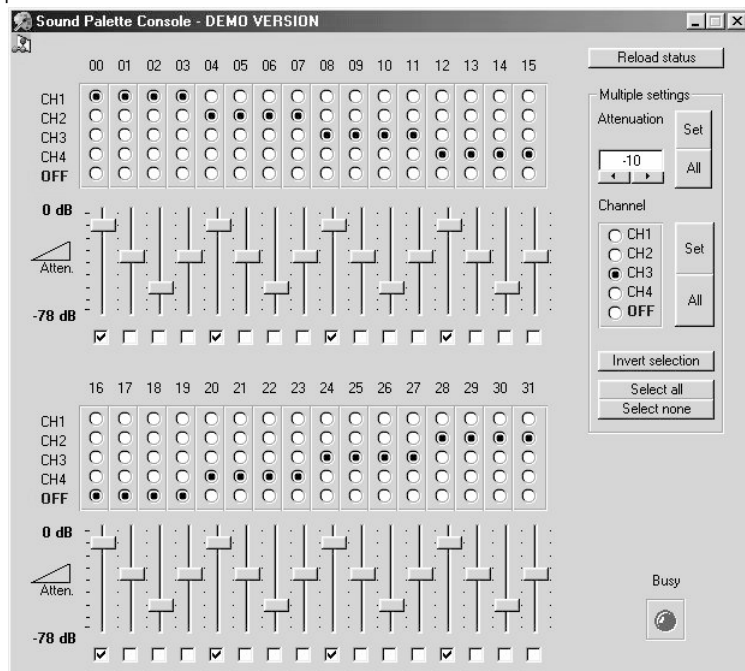

5. SPECIFICATIONS

SP2400 BLOCK DIAGRAM

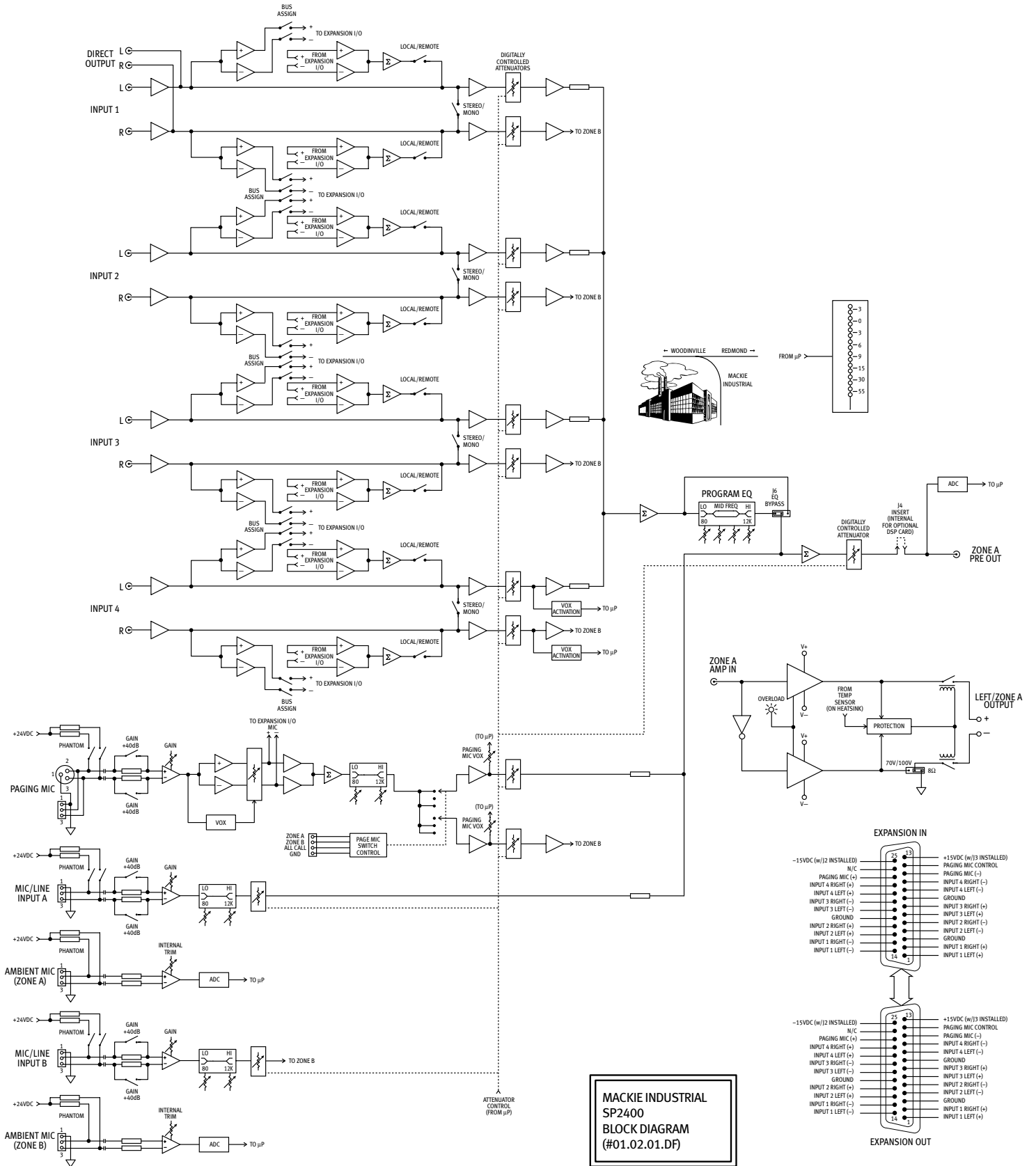

SP2400 SPECIFICATIONS

POWER AMPLIFIER SECTION

CONTINUOUS SINE WAVE AVERAGE OUTPUT POWER, BOTH CHANNELS DRIVEN:

200 watts per channel into 8 ohms from 20Hz to 20kHz, with no more than 0.01% THD

100V rms per channel into 50 ohms from 20Hz to 20kHz, with no more than 0.1% THD (J2/J3 in 100V position)

70V rms per channel into 25 ohms from 20Hz to 20kHz, with no more than 0.1% THD (J2/J3 in 70V position)

FREQUENCY RESPONSE

20Hz to 20kHz (+0, -0.5 dB)

DISTORTION

THD: < 0.01% @ rated output into 8 ohms

SIGNAL-TO-NOISE RATIO

> 90 dB below rated power into 8 ohms

> 100 dB (A-weighted) below rated power into 8 ohms

CHANNEL SEPARATION

> 80 dB @ 1kHz

AMP INPUT IMPEDANCE

20K ohms

INPUT SENSITIVITY

+5 dBu (1.37V rms) for rated power into 8 ohms

GAIN

27 dB (8-ohm position)

27 dB (70V position)

30 dB (100V position)

MAXIMUM INPUT LEVEL

12 volts P-P (+15 dBu)

RISE TIME

< 5 μ S

SLEW RATE

> 17 V/ μ S

PREAMPLIFIER SECTION

INPUT LEVELS

Program Inputs: -10 dBu to +10 dBu for maximum output level with internal AGC

Paging Mic Input: -52 dBu to +4 dBu

Local Mic Input: -52 dBu to +4 dBu

MAXIMUM INPUT

Program Inputs: +15 dBu

Mic Inputs: +15 dBu

MAXIMUM OUTPUT AT PRE OUT

+10 dBu

STEREO SEPARATION

> 45 dB at 1kHz

EQ

3-Band Program EQ:

High Shelving: ± 15 dB @ 12kHz

Mid Peaking: ± 15 dB with sweepable frequency (250Hz to 8kHz)

Low Shelving: ± 15 dB @ 80Hz

2-Band Mic EQ:

High Shelving: ± 12 dB @ 12kHz

Low Shelving: ± 12 dB @ 100Hz

GENERAL

POWER CONSUMPTION

700 watts with musical program, 8 ohms per side

800 watts maximum

PHANTOM POWER

24 VDC

AC LINE VOLTAGE

115VAC, 60Hz

230VAC, 50Hz

FUSE RATING

115V

8A Slow Blow, 250V

230V

4A Slow Blow, 250V

DIMENSIONS

Height: 3.5" (88mm)

Width: 19" (483mm)

Depth: 16.7" (424mm)

Weight: 40 lbs. (18.1kg)

ACCESSORIES

MT-3100

Ambient Noise Sensing Microphone

SP-41R

Remote Control

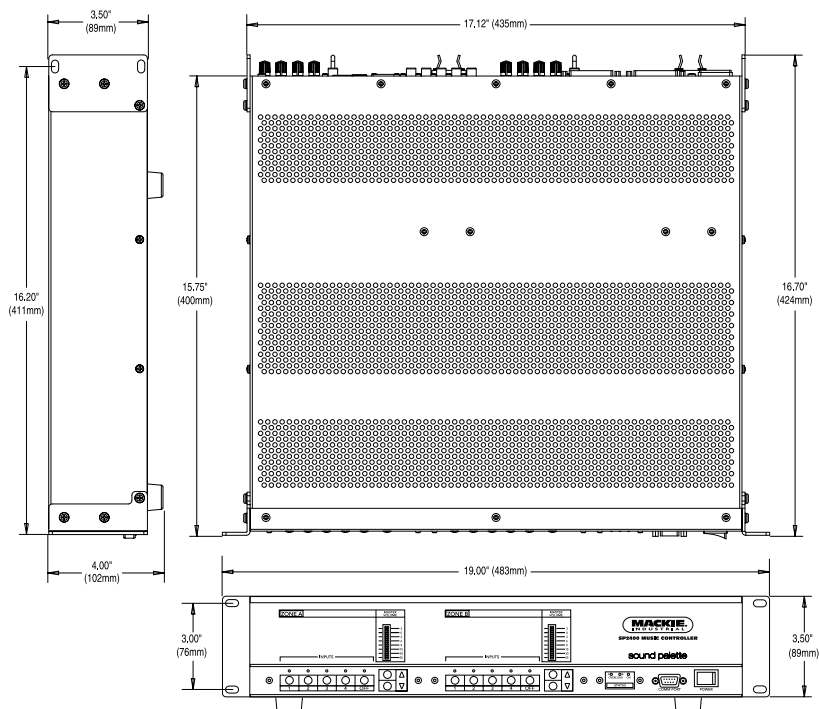

Disclaimer

Mackie Industrial continually engages in research related to product improvement, new materials, and production methods. Design refinements are introduced into existing products without notice as a routine expression of that philosophy. For this reason, any current Mackie Industrial product may differ in some respect from its published description, but will always equal or exceed the original design specifications unless otherwise stated.

Mackie Industrial and Sound Palette are trademarks or registered trademarks of Mackie Designs Inc.

All other brand names mentioned are trademarks or registered trademarks of their respective holders, and are hereby acknowledged.

© 2001 All Rights Reserved.
Mackie Industrial.
Printed in the U.S.A.

6. SERVICE INFORMATION

In the event that your SP2400 should require servicing, please follow these instructions:

1. Call Mackie Industrial Tech Support at 1-888-337-7404, 8 am to 5 pm PST (Monday-Friday), to verify the problem and obtain a Return Authorization (RA) Number. Be sure to have the serial number of the unit when you call. You must have a Return Authorization Number in order to obtain warranty service at the factory or at an authorized service center.
2. Pack the unit in its original packaging. This is very important. Mackie Industrial is not responsible for any damage that occurs during shipping due to non-conventional packaging. Original packaging helps to minimize the possibility of shipping damage.
3. Include a legible note stating your name, return shipping address, (no P.O. boxes), daytime phone number, Return Authorization Number, and a detailed description of the problem, including how we can duplicate it.
4. Write the Return Authorization Number in BIG BOLD PRINT on the top of the box.
5. Ship the unit to us. We suggest insurance for all forms of cartage. Ship to this address:

Mackie Industrial
Service Department
16140 Wood-Red Road NE, Suite 5
Woodinville, WA 98072

APPENDIX A: DEFAULT SETTINGS

Control	Setting	
LOCAL/REMOTE	UP (LOCAL)	
STEREO/MONO	DOWN (MONO)	
<u>PAGING MIC</u> PHANTOM	UP (OFF)	
GAIN +40dB	UP (0dB)	
GAIN	CENTER	
LOW	CENTER (FLAT)	
HIGH	CENTER (FLAT)	
AMP ADDRESS	ZONE A	ZONE B
	10000000	01000000
<u>MIC/LINE INPUT</u> GAIN	CENTER	CENTER
LOW	CENTER (FLAT)	CENTER (FLAT)
HIGH	CENTER (FLAT)	CENTER (FLAT)
PHANTOM	UP (OFF)	UP (OFF)
GAIN +40dB	UP (0dB)	UP (0dB)
MIC VOX	DOWN (OFF)	DOWN (OFF)
<u>PROGRAM EQ</u> LOW	CENTER (FLAT)	CENTER (FLAT)
MID	CENTER (FLAT)	CENTER (FLAT)
FREQ	CENTER (1kHz)	CENTER (1kHz)
HIGH	CENTER (FLAT)	CENTER (FLAT)
INTERNAL BUS ASSIGN (S1/S2)	OFF	

NOTE: All SP2400s sold in the U.S. and Canada are configured for 115V AC line input and 70V speaker output. All units sold outside the U.S. and Canada are configured for 230V AC and 100V speaker outputs. Please confirm your configuration prior to installation.

APPENDIX B: BUTTON MODES

SP2400 Button Modes

Press **1** on Power Up: **AGC Reset**

- Press and hold the Input 1 button while powering up the SP2400.
- Release the Input 1 button and the Input 1 LED blinks.
This resets the AGC for all four inputs to the default setting (-5 dBu).
- Press the Input 1 button again and the **OFF** LED lights. This indicates that the AGC circuit is turned off.
- Press the Input 1 button again and the **OFF** LED turns off. This indicates that the AGC circuit is turned on.
- Press the **OFF** button to save the settings and return to normal operation.

Press **2** on Power Up: **Ambient Mic Preamp Metering**

- Press and hold the Input 2 button while powering up the SP2400.
- Release the Input 2 button. The Ambient Mic Preamp gain is indicated on the LED meter.
- Use this mode to calibrate the ambient mic (see procedure on page 20).
- Press the **OFF** button to return to normal operation.

Press **3** on Power Up: **Paging Mic Level Adjustment**

- Press and hold the Input 3 button while powering up the SP2400.
- Release the Input 3 button. The lowest Paging Mic level is indicated on the LED meter.
- Use the Up/Down buttons to adjust the lowest Paging Mic level.
- Press the **OFF** button. The highest Paging Mic level is indicated on the LED meter.
- Use the Up/Down buttons to adjust the highest Paging Mic level (see procedure on page 20).
- Press the Input 3 button to save the settings and return to normal operation.

Press **4** on Power Up: **Firmware Version**

- Press and hold the Input 4 button while powering up the SP2400.
- Release the Input 4 button. The LEDs on the front panel indicate the firmware version in binary.
- The Input 1-4 LEDs indicate the digit to the left of the decimal point, and the LED meter indicates the digit to the right of the decimal point.
- For example, the following illustration indicates version 1.7.
- Press the **OFF** button to return to normal operation.

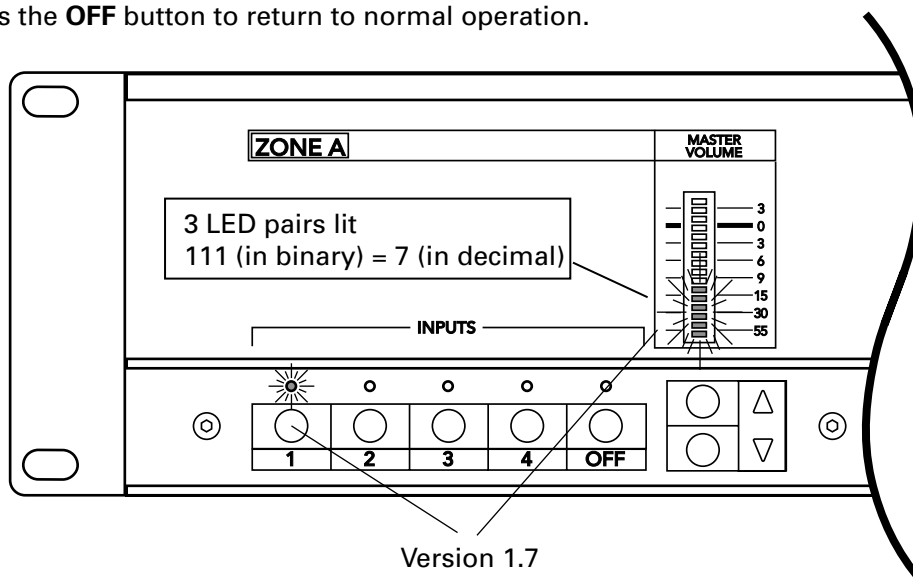

APPENDIX C: VOLTAGE CONVERSION



CAUTION: These servicing instructions are for use by qualified personnel only. To avoid electric shock, do not perform any servicing other than that contained in the Operating Instructions unless you are qualified to do so. Refer all servicing to qualified service personnel. *Make sure the power is off and the power cord disconnected* before removing the top cover to gain access to the inside of the SP2400.

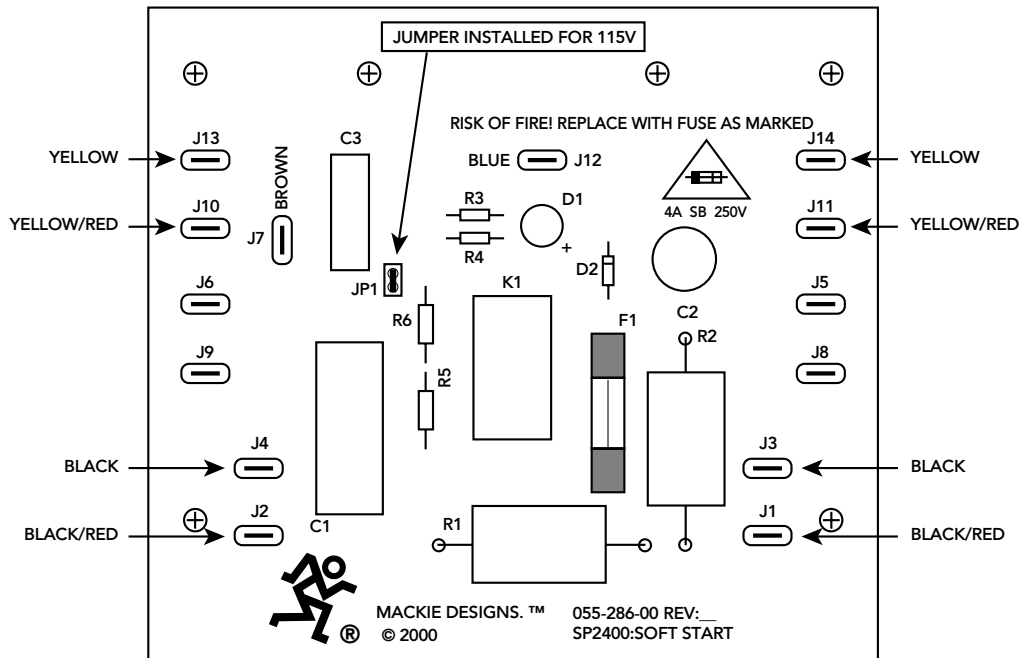

**SP2400: 115V AC CONFIGURATION
(8A, 250V SLOW BLOW FUSE INSTALLED IN IEC SOCKET)**

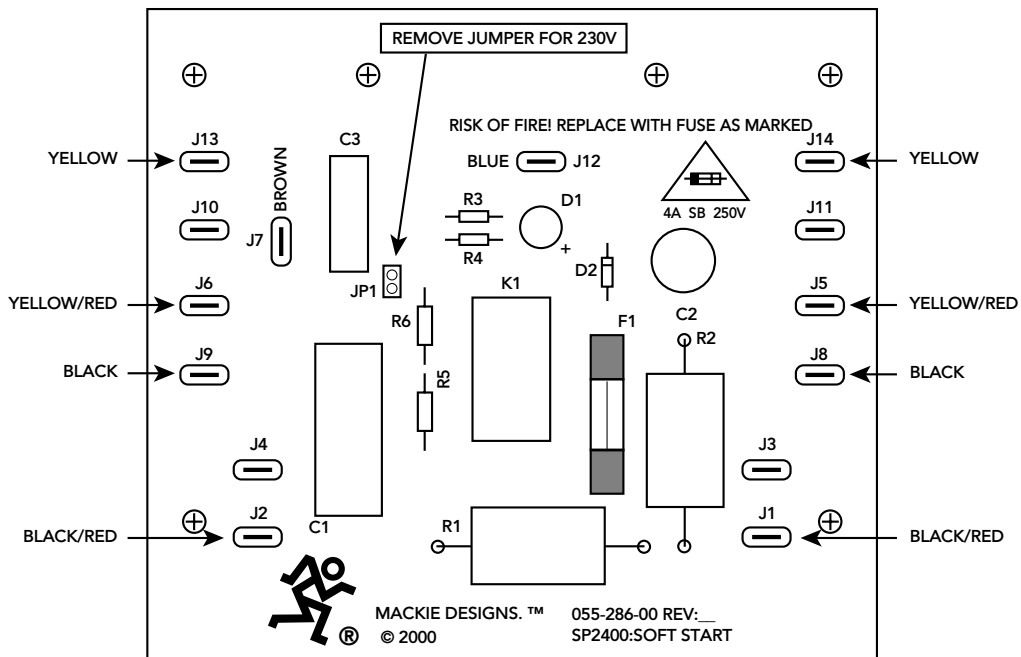

**SP2400: 230 VAC CONFIGURATION
(4A, 250V SLOW BLOW FUSE INSTALLED IN IEC SOCKET)**



SP2400 MUSIC CONTROLLER

Mackie Industrial

16220 Wood-Red Rd. NE • Woodinville, WA 98072 • USA
888/337-7404 • Outside the U.S.: 425/487-4333
Fax: 425/487-4337 • www.mackieindustrial.com